

Examples of single location, single population models using ordinary differential equations

Arba Minch – Course 02

Julien Arino

December 2023

Outline

Extensions of the KMK model

The SLIRS models and friends

Vector-borne diseases

Immunology

A few other models

Something different – Discrete-time

Extensions of the KMK model

The SLIRS models and friends

Vector-borne diseases

Immunology

A few other models

Something different – Discrete-time

Extensions of the KMK model

- The SLIAR model

 - Computing the final size more efficiently

 - A variation on the SLIAR model

 - A model with vaccination

 - Antiviral resistance

 - A COVID-19 model

Simple models for containment of a pandemic

Julien Arino^{1,*}, Fred Brauer², P. van den Driessche³, James Watmough⁴
and Jianhong Wu⁵

¹*Department of Mathematics, University of Manitoba, Winnipeg,
Manitoba R3T 2N2, Canada*

²*Department of Mathematics, University of British Columbia,
Vancouver, British Columbia V6T 1Z2, Canada*

³*Department of Mathematics and Statistics, University of Victoria,
Victoria, British Columbia V8W 3P4, Canada*

⁴*Department of Mathematics and Statistics, University of New Brunswick,
Fredericton, New Brunswick E3B 5A3, Canada*

⁵*Department of Mathematics and Statistics, York University,
Toronto, Ontario M3J 1P3, Canada*

SIR is a little too simple for many diseases:

- ▶ No incubation period
- ▶ A lot of infectious diseases (in particular respiratory) have mild and less mild forms depending on the patient

⇒ model with SIR but also L(atent) and (A)symptomatic individuals, in which I are now symptomatic individuals

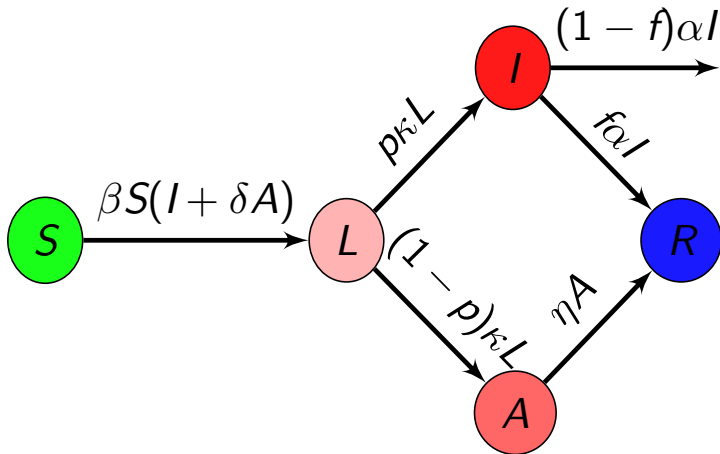

Basic reproduction number & Final size

We find the basic reproduction number

$$\mathcal{R}_0 = \beta \left(\frac{\rho}{\alpha} + \frac{\delta(1-\rho)}{\eta} \right) S_0 = \frac{\beta\rho}{\alpha} S_0 \quad (1)$$

where

$$\rho = \alpha \left(\frac{\rho}{\alpha} + \frac{\delta(1-\rho)}{\eta} \right)$$

The final size relation takes the form

$$S_0(\ln S_0 - \ln S_\infty) = \mathcal{R}_0(S_0 - S_\infty) + \frac{\mathcal{R}_0 I_0}{\rho} \quad (2)$$

Extensions of the KMK model

- The SLIAR model

- Computing the final size more efficiently

- A variation on the SLIAR model

- A model with vaccination

- Antiviral resistance

- A COVID-19 model

A FINAL SIZE RELATION FOR EPIDEMIC MODELS

JULIEN ARINO

Department of Mathematics, University of Manitoba
Winnipeg, Manitoba R3T 2N2, Canada

FRED BRAUER

Department of Mathematics, University of British Columbia
Vancouver, BC V6T 1Z2, Canada

P. VAN DEN DRIESSCHE

Department of Mathematics and Statistics, University of Victoria
Victoria, B.C. V8W 3P4, Canada

JAMES WATMOUGH

Department of Mathematics and Statistics, University of New Brunswick
Fredericton, N.B. E3B 5A3, Canada

JIANHONG WU

Department of Mathematics and Statistics, York University
Toronto, Ontario M3J 1P3, Canada

(Communicated by Zhilan Feng)

A method for computing \mathcal{R}_0 in epidemic models

- ▶ This method is not universal! It works in a relatively large class of models, but not everywhere

- ▶ If it doesn't work, the next generation matrix method does work, **but** should be considered only for obtaining the reproduction number, not to deduce LAS

- ▶ Here, I change the notation in the paper, for convenience

Standard form of the system

Suppose system can be written in the form

$$\mathbf{S}' = \mathbf{b}(\mathbf{S}, \mathbf{I}, \mathbf{R}) - \mathbf{D}\mathbf{S}\beta(\mathbf{S}, \mathbf{I}, \mathbf{R})h\mathbf{I} \quad (3a)$$

$$\mathbf{I}' = \mathbf{\Pi}\mathbf{D}\mathbf{S}\beta(\mathbf{S}, \mathbf{I}, \mathbf{R})h\mathbf{I} - \mathbf{V}\mathbf{I} \quad (3b)$$

$$\mathbf{R}' = \mathbf{f}(\mathbf{S}, \mathbf{I}, \mathbf{R}) + \mathbf{W}\mathbf{I} \quad (3c)$$

where $\mathbf{S} \in \mathbb{R}^m$, $\mathbf{I} \in \mathbb{R}^n$ and $\mathbf{R} \in \mathbb{R}^k$ are susceptible, infected and removed compartments, respectively

IC are ≥ 0 with at least one of the components of $\mathbf{I}(0)$ positive

$$\mathbf{S}' = \mathbf{b}(\mathbf{S}, \mathbf{I}, \mathbf{R}) - \mathbf{D}\mathbf{S}\beta(\mathbf{S}, \mathbf{I}, \mathbf{R})\mathbf{h} \quad (3a)$$

- ▶ $\mathbf{b} : \mathbb{R}_+^m \times \mathbb{R}_+^n \times \mathbb{R}_+^k \rightarrow \mathbb{R}^m$ continuous function encoding recruitment and death of uninfected individuals
- ▶ $\mathbf{D} \in \mathbb{R}^{m \times m}$ diagonal with diagonal entries $\sigma_i > 0$ the relative susceptibilities of susceptible compartments, with convention that $\sigma_1 = 1$
- ▶ Scalar valued function $\beta : \mathbb{R}_+^m \times \mathbb{R}_+^n \times \mathbb{R}_+^k \rightarrow \mathbb{R}_+$ represents infectivity, with, e.g., $\beta(\mathbf{S}, \mathbf{I}, \mathbf{R}) = \beta$ for mass action
- ▶ $\mathbf{h} \in \mathbb{R}^n$ row vector of relative horizontal transmissions

$$I' = \Pi D S \beta(\mathbf{S}, \mathbf{I}, \mathbf{R}) \mathbf{h} I - \mathbf{V} I \quad (3b)$$

- ▶ $\Pi \in \mathbb{R}^{n \times m}$ has (i, j) entry the fraction of individuals in j^{th} susceptible compartment that enter i^{th} infected compartment upon infection
- ▶ $D \in \mathbb{R}^{m \times m}$ diagonal with diagonal entries $\sigma_i > 0$ the relative susceptibilities of susceptible compartments, with convention that $\sigma_1 = 1$
- ▶ Scalar valued function $\beta : \mathbb{R}_+^m \times \mathbb{R}_+^n \times \mathbb{R}_+^k \rightarrow \mathbb{R}_+$ represents infectivity, with, e.g., $\beta(\mathbf{S}, \mathbf{I}, \mathbf{R}) = \beta$ for mass action
- ▶ $\mathbf{h} \in \mathbb{R}^n$ row vector of relative horizontal transmissions
- ▶ $\mathbf{V} \in \mathbb{R}^{n \times n}$ describes transitions between infected states and removals from these states due to recovery or death

$$R' = f(S, I, R) + WI \quad (3c)$$

- ▶ $f: \mathbb{R}_+^m \times \mathbb{R}_+^n \times \mathbb{R}_+^k \rightarrow \mathbb{R}^k$ continuous function encoding flows into and out of removed compartments because of immunisation or similar processes
- ▶ $W \in \mathbb{R}^{k \times n}$ has (i, j) entry the rate at which individuals in the j^{th} infected compartment move into the i^{th} removed compartment

Suppose \mathbf{E}_0 is a locally stable disease-free equilibrium (DFE) of the system without disease, i.e., an EP of

$$\mathbf{S}' = \mathbf{b}(\mathbf{S}, \mathbf{0}, \mathbf{R})$$

$$\mathbf{R}' = \mathbf{f}(\mathbf{S}, \mathbf{0}, \mathbf{R})$$

Theorem 1

Let

$$\mathcal{R}_0 = \beta(\mathbf{S}_0, \mathbf{0}, \mathbf{R}_0) \mathbf{h} \mathbf{V}^{-1} \mathbf{\Pi} \mathbf{D} \mathbf{S}_0 \quad (4)$$

- ▶ If $\mathcal{R}_0 < 1$, the DFE \mathbf{E}_0 is a locally asymptotically stable EP of (3)
- ▶ If $\mathcal{R}_0 > 1$, the DFE \mathbf{E}_0 of (3) is unstable

If no demography (epidemic model), then just \mathcal{R}_0 , of course

Final size relations

Assume no demography, then system should be writeable as

$$\mathbf{S}' = -\mathbf{D}\mathbf{S}\beta(\mathbf{S}, \mathbf{I}, \mathbf{R})h\mathbf{I} \quad (5a)$$

$$\mathbf{I}' = \mathbf{\Pi}\mathbf{D}\mathbf{S}\beta(\mathbf{S}, \mathbf{I}, \mathbf{R})h\mathbf{I} - \mathbf{V}\mathbf{I} \quad (5b)$$

$$\mathbf{R}' = \mathbf{W}\mathbf{I} \quad (5c)$$

For $w(t) \in \mathbb{R}_+^n$ continuous, define

$$w_\infty = \lim_{t \rightarrow \infty} w(t) \quad \text{and} \quad \hat{w} = \int_0^\infty w(t) dt$$

Define the row vector

$$\mathbb{R}^m \ni \mathbf{\Gamma} = (\Gamma_1, \dots, \Gamma_m) = \beta(\mathbf{S}_0, \mathbf{0}, \mathbf{R}_0) h \mathbf{V}^{-1} \mathbf{\Pi} \mathbf{D}$$

then

$$\mathcal{R}_0 = \mathbf{\Gamma} \mathbf{S}(0)$$

Suppose incidence is mass action, i.e., $\beta(\mathbf{S}, \mathbf{I}, \mathbf{R}) = \beta$ and $m > 1$

Then for $i = 1, \dots, m$, express $\mathbf{S}_i(\infty)$ as a function of $\mathbf{S}_1(\infty)$ using

$$\mathbf{S}_i(\infty) = \mathbf{S}_i(0) \left(\frac{\mathbf{S}_1(\infty)}{\mathbf{S}_1(0)} \right)^{\sigma_i/\sigma_1}$$

then substitute into

$$\begin{aligned} \frac{1}{\sigma_i} \ln \left(\frac{\mathbf{S}_i(0)}{\mathbf{S}_i(\infty)} \right) &= \mathbf{\Gamma} \mathbf{D}^{-1} (\mathbf{S}(0) - \mathbf{S}(\infty)) + \beta \mathbf{h} \mathbf{V}^{-1} \mathbf{I}(0) \\ &= \frac{1}{\sigma_1} \ln \left(\frac{\mathbf{S}_1(0)}{\mathbf{S}_1(\infty)} \right) \end{aligned}$$

which is a final size relation for the general system when $\mathbf{S}_i(0) > 0$

If incidence is mass action and $m = 1$ (only one susceptible compartment), reduces to the KMK form

$$\ln \left(\frac{S_0}{S_\infty} \right) = \frac{\mathcal{R}_0}{S_0} (S_0 - S_\infty) + \beta \mathbf{hV}^{-1} \mathbf{I}_0 \quad (6)$$

In the case of more general incidence functions, the final size relations are inequalities of the form, for $i = 1, \dots, m$,

$$\ln \left(\frac{\mathbf{S}_i(0)}{\mathbf{S}_i(\infty)} \right) \geq \sigma_i \mathbf{\Gamma} \mathbf{D}^{-1} (\mathbf{S}(0) - \mathbf{S}(\infty)) + \sigma_i \beta(K) h \mathbf{V}^{-1} \mathbf{I}(0)$$

where K is the initial total population

Extensions of the KMK model

- The SLIAR model

- Computing the final size more efficiently

- A variation on the SLIAR model

- A model with vaccination

- Antiviral resistance

- A COVID-19 model

The SLIAR model

- ▶ Paper we have already seen: Arino, Brauer, PvdD, Watmough & Wu. Simple models for containment of a pandemic, *Journal of the Royal Society Interface* (2006)

- ▶ However, suppose additionally that L are also infectious

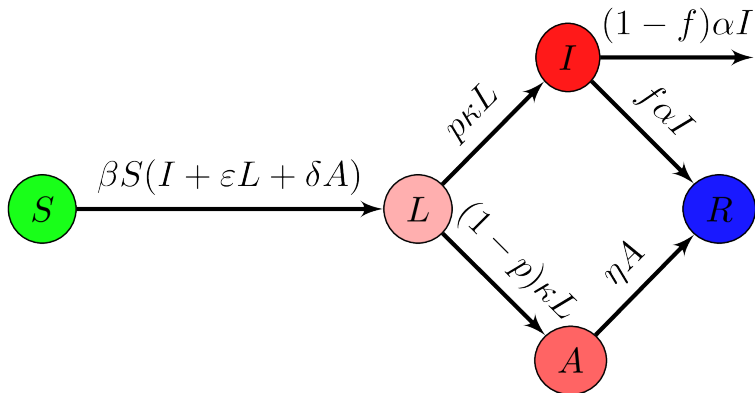

Here, $\mathbf{S} = S$, $\mathbf{I} = (L, I, A)^T$ and $\mathbf{R} = R$, so $m = 1$, $n = 3$ and

$$\mathbf{h} = [\varepsilon \ 1 \ \delta], \quad \mathbf{D} = \mathbf{1}, \quad \mathbf{\Pi} = \begin{pmatrix} 1 \\ 0 \\ 0 \end{pmatrix} \quad \text{and} \quad \mathbf{V} = \begin{pmatrix} \kappa & 0 & 0 \\ -\rho\kappa & \alpha & 0 \\ -(1-\rho)\kappa & 0 & \eta \end{pmatrix}$$

Incidence is mass action so $\beta(\mathbf{E}_0) = \beta$ and thus

$$\begin{aligned} \mathcal{R}_0 &= \beta \mathbf{h} \mathbf{V}^{-1} \mathbf{\Pi} \mathbf{D} \mathbf{S}_0 \\ &= \beta [\varepsilon \ 1 \ \delta] \begin{pmatrix} 1/\kappa & 0 & 0 \\ \rho/\alpha & 1/\alpha & 0 \\ (1-\rho)/\eta & 0 & 1/\eta \end{pmatrix} \begin{pmatrix} 1 \\ 0 \\ 0 \end{pmatrix} S_0 \\ &= \beta S_0 \left(\frac{\varepsilon}{\kappa} + \frac{\rho}{\alpha} + \frac{\delta(1-\rho)}{\eta} \right) \end{aligned}$$

For final size, since $m = 1$, we can use (6):

$$\ln \left(\frac{S_0}{S_\infty} \right) = \frac{\mathcal{R}_0}{S_0} (S_0 - S_\infty) + \beta h \mathbf{V}^{-1} \mathbf{l}_0$$

Suppose $\mathbf{l}_0 = (0, l_0, 0)$, then

$$\ln \left(\frac{S_0}{S_\infty} \right) = \mathcal{R}_0 \frac{S_0 - S_\infty}{S_0} + \frac{\beta}{\alpha} l_0$$

If $\mathbf{l}_0 = (L_0, l_0, A_0)$, then

$$\ln \left(\frac{S_0}{S_\infty} \right) = \mathcal{R}_0 \frac{S_0 - S_\infty}{S_0} + \beta \left(\frac{\varepsilon}{\kappa} + \frac{p}{\alpha} + \frac{\delta(1-p)}{\eta} \right) L_0 + \frac{\beta\delta}{\eta} A_0 + \frac{\beta}{\alpha} l_0$$

Extensions of the KMK model

- The SLIAR model

- Computing the final size more efficiently

- A variation on the SLIAR model

- A model with vaccination

- Antiviral resistance

- A COVID-19 model

A model with vaccination

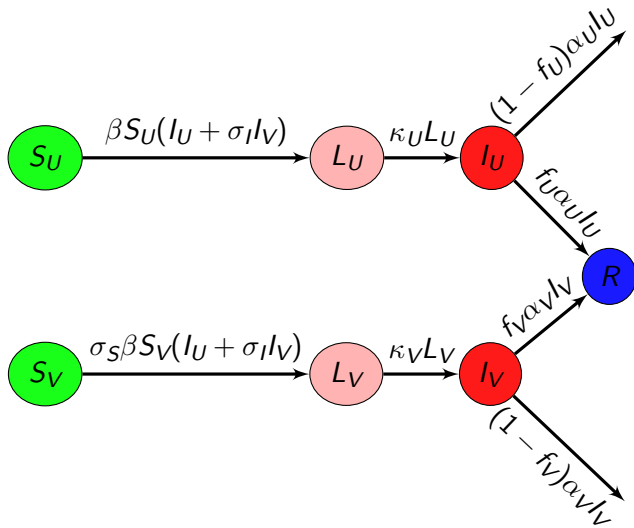

A model with vaccination

Fraction γ of S_0 are vaccinated before the epidemic; vaccination reduces probability and duration of infection, infectiousness and reduces mortality

$$S_U' = -\beta S_U [I_U + \sigma_I I_V] \quad (7a)$$

$$S_V' = -\sigma_S \beta S_V [I_U + \sigma_I I_V] \quad (7b)$$

$$L_U' = \beta S_U [I_U + \sigma_I I_V] - \kappa_U L_U \quad (7c)$$

$$L_V' = \sigma_S \beta S_V [I_U + \sigma_I I_V] - \kappa_V L_V \quad (7d)$$

$$I_U' = \kappa_U L_U - \alpha_U I_U \quad (7e)$$

$$I_V' = \kappa_V L_V - \alpha_V I_V \quad (7f)$$

$$R' = f_U \alpha_U I_U + f_V \alpha_V I_V \quad (7g)$$

with $S_U(0) = (1 - \gamma)S_0$ and $S_V(0) = \gamma S_0$

Here, $m = 2$, $n = 4$,

$$\mathbf{h} = [0 \ 0 \ 1 \ \sigma_I], \quad \mathbf{D} = \begin{pmatrix} 1 & 0 \\ 0 & \sigma_S \end{pmatrix}, \quad \mathbf{\Pi} = \begin{pmatrix} 1 & 0 \\ 0 & 1 \\ 0 & 0 \\ 0 & 0 \end{pmatrix}$$

and

$$\mathbf{V} = \begin{pmatrix} \kappa_U & 0 & 0 & 0 \\ 0 & \kappa_V & 0 & 0 \\ -\kappa_U & 0 & \alpha_U & 0 \\ 0 & -\kappa_V & 0 & \alpha_V \end{pmatrix}$$

So

$$\mathbf{\Gamma} = \begin{bmatrix} \beta & \sigma_I \sigma_S \beta \\ \alpha_U & \alpha_V \end{bmatrix}, \quad \mathcal{R}_c = S_0 \beta \left(\frac{1 - \gamma}{\alpha_U} + \frac{\sigma_I \sigma_S \gamma}{\alpha_V} \right)$$

and the final size relation is

$$\ln \left(\frac{(1 - \gamma) S_U(0)}{S_U(\infty)} \right) = \frac{\beta}{\alpha_U} [(1 - \gamma) S_U(0) - S_U(\infty)] + \frac{\sigma_I \beta}{\alpha_V} [\gamma S_V(0) - S_V(\infty)] + \frac{\beta}{\alpha_U} I_0$$

$$S_V(\infty) = \gamma S_U(0) \left(\frac{S_U(\infty)}{(1 - \gamma) S_0} \right)^{\sigma_S}$$

Extensions of the KMK model

- The SLIAR model

- Computing the final size more efficiently

- A variation on the SLIAR model

- A model with vaccination

- Antiviral resistance

- A COVID-19 model

Research article

Open Access

Antiviral resistance during pandemic influenza: implications for stockpiling and drug use

Julien Arino^{1,2}, Christopher S Bowman^{2,3} and Seyed M Moghadas^{*2,4,5}

Address: ¹Department of Mathematics, University of Manitoba, Winnipeg, Manitoba R3T 2N2, Canada, ²Institute for Biodiagnostics, National Research Council Canada, Winnipeg, Manitoba R3B 1Y6, Canada, ³Department of Electrical and Computer Engineering, University of Manitoba, Winnipeg, Manitoba R3T 5V6, Canada, ⁴Department of Mathematics and Statistics, University of Winnipeg, Winnipeg, Manitoba R3B 2E9, Canada and ⁵Department of Statistics, University of Manitoba, Winnipeg, Manitoba R3T 2N2, Canada

Email: Julien Arino - arinoj@cc.umanitoba.ca; Christopher S Bowman - chris.bowman@nrc-cnrc.gc.ca; Seyed M Moghadas* - seyed.moghadas@nrc-cnrc.gc.ca

* Corresponding author

Published: 22 January 2009

BMC Infectious Diseases 2009, 9:8 doi:10.1186/1471-2334-9-8

Received: 5 August 2008

Accepted: 22 January 2009

Adapting treatment to counter emergence of resistance

This work was undertaken at the request of the Public Health Agency of Canada during the pandemic preparedness phase prior to the 2009 p-H1N1 pandemic

Problem: we have antivirals to use against influenza, either prophylactically or curatively. Using these antivirals may promote the emergence of antiviral-resistant strains. How do we minimise this risk?

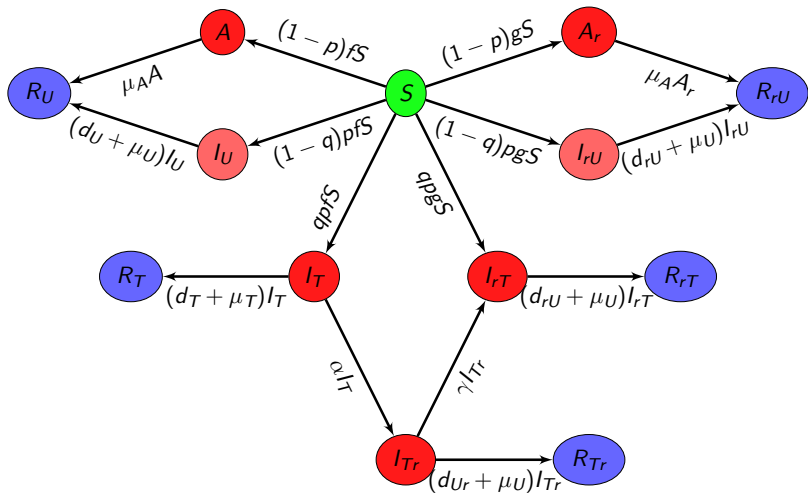

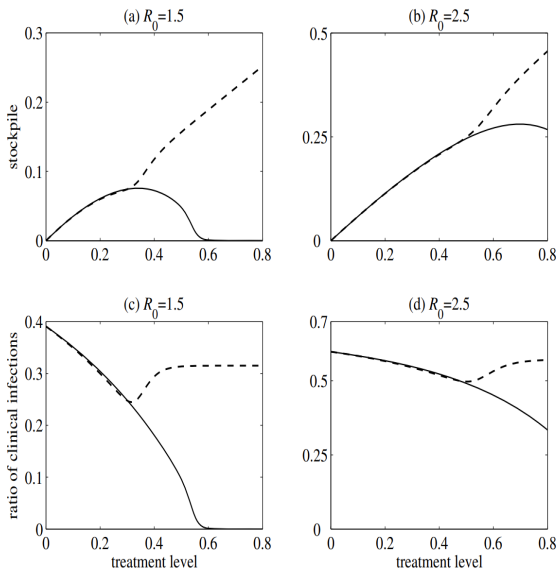

Figure 2

Required antiviral stockpile and ratio of the total clinical infections. Required stockpile of antiviral drugs (relative to S_0) as a function of the treatment level for (a) $R_0 = 1.5$; and (b) $R_0 = 2.5$. Ratio of the total number of clinical infections to S_0 as a function of the treatment level for: (c) $R_0 = 1.5$; and (d) $R_0 = 2.5$. Solid curves correspond to the case where resistance is absent, and dashed curves represent the scenario in which resistant viruses with HTF are present.

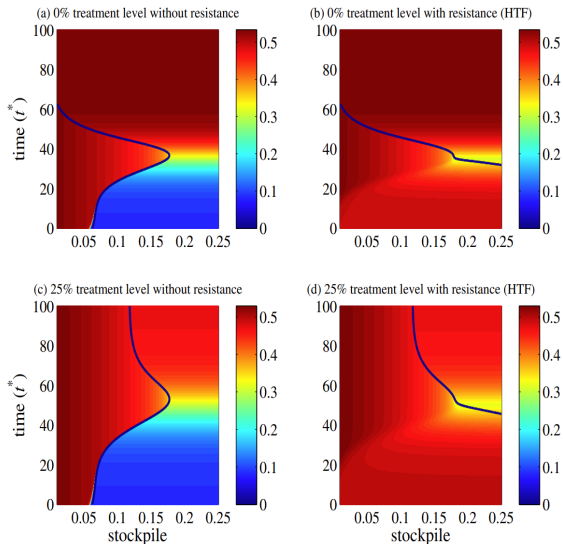

Figure 5

Final size of infections with adaptive treatment strategy.

The effect of changing treatment level during the outbreak on the total number of clinical infections caused by all strains, with various sizes of stockpile and $R_0 = 2$. Simulations were seeded with an initial treatment level of: (a) 0% without resistance; (b) 0% with resistance; (c) 25% without resistance; (d) 25% with resistance, and then changed to 80% at the time displayed on the vertical axis (corresponding to the time-course of the outbreak). The color bars illustrate the ratio of the total number of clinical infection to S_0 due to all strains. Run-out occurs in the regions consisting of the origin and delimited by the solid curves.

Extensions of the KMK model

- The SLIAR model

- Computing the final size more efficiently

- A variation on the SLIAR model

- A model with vaccination

- Antiviral resistance

- A COVID-19 model



A simple model for COVID-19

Julien Arino ^{a, b, c, *}, Stéphanie Portet ^a

^a Department of Mathematics & Data Science NEXUS, University of Manitoba, Canada

^b Centre for Disease Modelling, Canada

^c Canadian COVID-19 Mathematical Modelling Task Force, Canada



Extends the SLIAR model to take into account non-exponentially distributed stage durations (see lecture on Stochastic epidemiological models)

The original model (well, almost the first one)

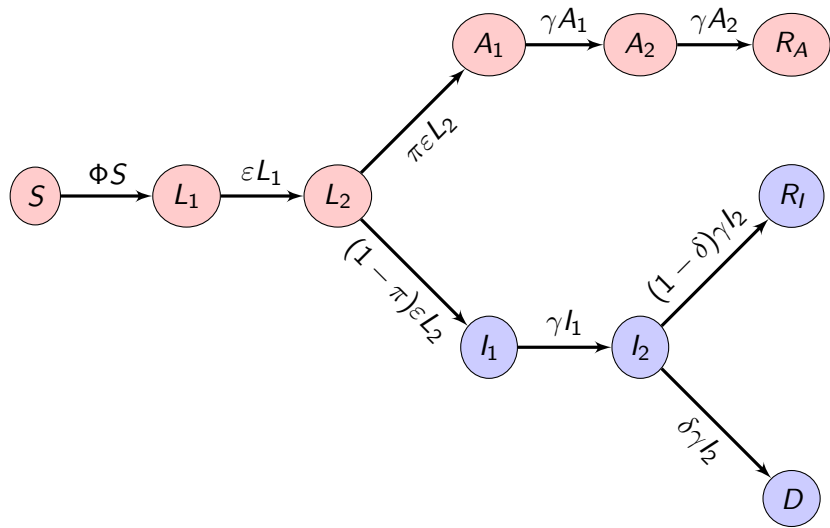

Reinterpreting terms

Here D stands for *detected*, U is *undetected*

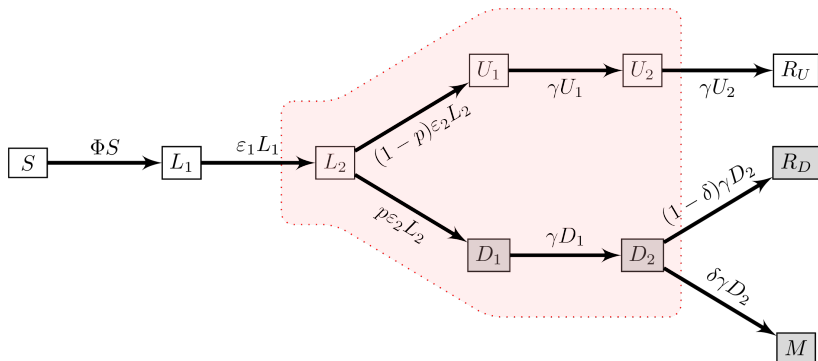

Working out when the first COVID-19 case occurred

- ▶ Details of emergence and precise timeline before amplification started unknown
- ▶ Amplification in Wuhan
 - ▶ Cluster of pneumonia cases mostly related to the Huanan Seafood Market
 - ▶ 27 December 2019: first report to local government
 - ▶ 31 December 2019: publication
 - ▶ 8 January 2020: identification of SARS-CoV-2 as causative agent
 - ▶ ~ 23 January 2020: lockdown Wuhan and Hubei province + face mask mandates
- ▶ By 2020-01-29, virus in all provinces of mainland CHN

Evidence of earlier spread

- ▶ Report to Wuhan authorities on 27 December 2019
 - ▶ First export detections in Thailand and Japan on 13 and 16 January 2020 (with actual importations on 8 and 6 January)
- ⇒ amplification must have been occurring for a while longer
- ▶ France: sample taken from 42-year-old male (last foreign travel to Algeria in August 2019) who presented to ICU on 27 December 2019
 - ▶ Retrospective studies in United Kingdom and Italy also showed undetected COVID-19 cases in prepandemic period

Untangling the first case issue

- ▶ Robert, Rossman & Jaric. Dating first cases of COVID-19. *PLoS Pathogens* (2021)
Find likely timing of first case of COVID-19 in China as November 17 (95% CI October 4)

- ▶ Pekar, Worobey, Moshiri, Scheffler & Wertheim. Timing the SARS-CoV-2 index case in Hubei province. *Science* (2021)
Period between mid-October and mid-November 2019 is plausible interval when the first case of SARS-CoV-2 emerged in Hubei province

Important when trying to understand global spread, so let me illustrate with the model I used, taking into account model evolution since

Back-calculating the start of spread (example of China)

Cumulative confirmed case counts in China as reported to WHO was $c = 547$ cases on $t_c = 2020-01-22$

Let u be a point in parameter space. Solve ODE numerically over $[0, t]$, with $S(0)$ the population of China, $L_1(0) = 1$ and other state variables 0. This gives a solution $x(t, t_0 = 0, u)$

Extracting $L_2(t, t_0 = 0, u)$ from this solution, obtain cumulative number of new detections as

$$C(t) = \int_{t_0=0}^t p_{E2} L_2(s, t_0, u) ds$$

Let t^* be s.t. $C(t^*) = 547$; then $t_i = 2020-01-22 - t^*$

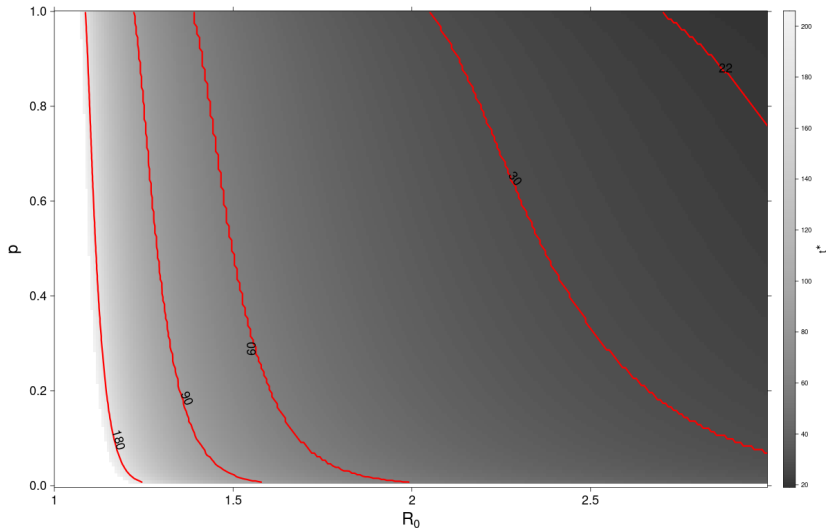

Extensions of the KMK model

The SLIRS models and friends

Vector-borne diseases

Immunology

A few other models

Something different – Discrete-time

The SLIRS models and friends

- SIS models

- SLIRS model with constant population

- Computing \mathcal{R}_0 more efficiently

- Global properties of the SLIRS model

- SLIRS in variable population

- A better vaccination model

Note on demography

- ▶ We have already discussed some different possible forms for demography

- ▶ In the models with demography here, unless otherwise required, we use demography such that for the total population

$$N' = b - dN$$

Simplifying the SIRS model

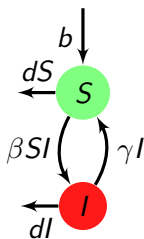

► We have already seen the epidemic KMK SIR model and the endemic SIRS model

► By making some simplifications of the endemic SIRS model, we obtain the SIS model: assume the time spent in the R compartment goes to zero, i.e., $\nu \rightarrow \infty$

The main characteristics of the model are the same as the SIRS

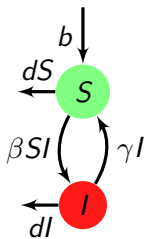

$$S' = b + \gamma I - dS - \beta SI \quad (8a)$$

$$I' = \beta SI - (d + \gamma)I \quad (8b)$$

with initial conditions $S(0) = S_0 \geq 0$ and $I(0) = I_0 \geq 0$

Clearly, the DFE is similar as for the SIRS

$$\mathbf{E}_0 := (S^*, I^*) = (N^*, 0)$$

with $N^* = b/d$. Also easy to check (exercise!) that

$$\mathcal{R}_0 = \frac{\beta}{d + \gamma}$$

The SLIRS models and friends

- SIS models

- SLIRS model with constant population

- Computing \mathcal{R}_0 more efficiently

- Global properties of the SLIRS model

- SLIRS in variable population

- A better vaccination model

Incubation periods

- ▶ SIS and SIR: progression from S to I is instantaneous
- ▶ Several incubation periods:

Disease	Incubation period
Yersinia Pestis	2-6 days
Ebola haemorrhagic fever (HF)	2-21 days
Marburg HF	5-10 days
Lassa fever	1-3 weeks
Tse-tse	weeks–months
HIV/AIDS	months–years

Hypotheses

- ▶ There is demography
- ▶ New individuals are born at a constant rate b
- ▶ There is no vertical transmission: all “newborns” are susceptible
- ▶ The disease is non lethal, it causes no additional mortality
- ▶ New infections occur at the rate $f(S, I, N)$
- ▶ There is a period of incubation for the disease
- ▶ There is a period of time after recovery during which the disease confers immunity to reinfection (immune period)

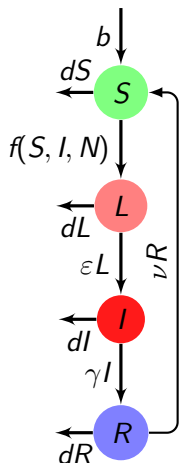

The model is as follows:

$$S' = b + \nu R - dS - f(S, I, N) \quad (9a)$$

$$L' = f(S, I, N) - (d + \epsilon)L \quad (9b)$$

$$I' = \epsilon L - (d + \gamma)I \quad (9c)$$

$$R' = \gamma I - (d + \nu)R \quad (9d)$$

Meaning of the parameters:

- ▶ $1/\epsilon$ average duration of the incubation period
- ▶ $1/\gamma$ average duration of infectious period
- ▶ $1/\nu$ average duration of immune period

The SLIRS models and friends

- SIS models

- SLIRS model with constant population

- Computing \mathcal{R}_0 more efficiently

- Global properties of the SLIRS model

- SLIRS in variable population

- A better vaccination model



ELSEVIER

Mathematical Biosciences 180 (2002) 29–48

**Mathematical
Biosciences**

www.elsevier.com/locate/mbs

Reproduction numbers and sub-threshold endemic equilibria for compartmental models of disease transmission

P. van den Driessche ^{a,1}, James Watmough ^{b,*,2}

^a *Department of Mathematics and Statistics, University of Victoria, Victoria, BC, Canada V8W 3P4*

^b *Department of Mathematics and Statistics, University of New Brunswick, Fredericton, NB, Canada E3B 5A3*

Received 26 April 2001; received in revised form 27 June 2001; accepted 27 June 2001

Dedicated to the memory of John Jacquez

The basic reproduction number \mathcal{R}_0

Used frequently in epidemiology (not only math epi)

Definition 2 (R_0)

The basic reproduction number \mathcal{R}_0 is the average number of secondary cases generated by the introduction of an infectious individual in a wholly susceptible population

- ▶ If $\mathcal{R}_0 < 1$, then on average, each infectious individual infects less than one other person, so the epidemic has chances of dying out
- ▶ If $\mathcal{R}_0 > 1$, then on average, each infectious individual infects more than one other person and the disease can become established in the population (or there will be a major epidemic)

Computation of \mathcal{R}_0

Mathematically, \mathcal{R}_0 is a bifurcation parameter aggregating some of the model parameters and such that the disease free equilibrium (DFE) loses its local asymptotic stability when $\mathcal{R}_0 = 1$ is crossed from left to right

- ▶ As a consequence, \mathcal{R}_0 is found by considering the spectrum of the Jacobian matrix of the system evaluated at the DFE
- ▶ The matrix quickly becomes hard to deal with (size and absence of “pattern”) and the form obtained is not unique, which is annoying when trying to interpret \mathcal{R}_0

The next generation operator

Diekmann and Heesterbeek, characterized in the ODE context by van den Driessche and Watmough

Consider only individuals harbouring the pathogen, in a vector \mathcal{I} , and form the vectors

- ▶ \mathcal{F} of infection fluxes
- ▶ \mathcal{V} of other fluxes (with $-$ sign)

so that

$$\mathcal{I}' = \mathcal{F} - \mathcal{V}$$

Then compute the Fréchet derivatives $D\mathcal{F}$ and $D\mathcal{V}$ with respect to the infected variables \mathcal{I} and evaluate $F = D\mathcal{F}(DFE)$ and $V = D\mathcal{V}(DFE)$. Then

$$\mathcal{R}_0 = \rho(FV^{-1})$$

where ρ is the spectral radius

Short summary of van den Driessche and Watmough

Theorem 3 (van den Driessche and Watmough)

Suppose that the DFE exists. Let then \mathcal{R}_0 be defined by

$$\mathcal{R}_0 = \rho(FV^{-1})$$

with matrices F and V as indicated before. Then,

- ▶ *if $\mathcal{R}_0 < 1$, the DFE is LAS,*
- ▶ *if $\mathcal{R}_0 > 1$, the DFE is unstable.*

Example of the SLIRS model (9)

Variation of the infected variables in (9) are described by

$$\begin{aligned}L' &= f(S, I, N) - (\varepsilon + d)L \\I' &= \varepsilon L - (d + \gamma)I\end{aligned}$$

Write

$$\mathcal{I}' = \begin{pmatrix} L \\ I \end{pmatrix}' = \begin{pmatrix} f(S, I, N) \\ 0 \end{pmatrix} - \begin{pmatrix} (\varepsilon + d)L \\ (d + \gamma)I - \varepsilon L \end{pmatrix} =: \mathcal{F} - \mathcal{V} \quad (10)$$

Denote

$$f_L^* := \left. \frac{\partial}{\partial L} f \right|_{(S,I,R)=\mathbf{E}_0} \quad f_I^* := \left. \frac{\partial}{\partial I} f \right|_{(S,I,R)=\mathbf{E}_0}$$

the values of the partials of the incidence function at the DFE \mathbf{E}_0

Compute the Jacobian matrices of vectors \mathcal{F} and \mathcal{V} at the DFE \mathbf{E}_0

$$F = \begin{pmatrix} f_L^* & f_I^* \\ 0 & 0 \end{pmatrix} \quad \text{and} \quad V = \begin{pmatrix} \varepsilon + d & 0 \\ -\varepsilon & d + \gamma \end{pmatrix} \quad (11)$$

Thus

$$V^{-1} = \frac{1}{(d+\varepsilon)(d+\gamma)} \begin{pmatrix} d+\gamma & 0 \\ \varepsilon & d+\varepsilon \end{pmatrix}$$

Also, in the case N is constant, $\partial f/\partial L = 0$ and thus

$$FV^{-1} = \frac{f_l^*}{(d+\varepsilon)(d+\gamma)} \begin{pmatrix} \varepsilon & d+\varepsilon \\ 0 & 0 \end{pmatrix}$$

As a consequence,

$$\mathcal{R}_0 = \varepsilon \frac{f_l^*}{(d+\varepsilon)(d+\gamma)}$$

Theorem 4

Let

$$\mathcal{R}_0 = \frac{\varepsilon f_I^*}{(d + \varepsilon)(d + \gamma)} \quad (12)$$

Then

- ▶ if $\mathcal{R}_0 < 1$, the DFE is LAS
- ▶ if $\mathcal{R}_0 > 1$, the DFE is unstable

It is important here to stress that the result we obtain concerns the **local** asymptotic stability. We see later that even when $\mathcal{R}_0 < 1$, there can be several locally asymptotically stable equilibria

Application

The DFE is

$$(\bar{S}, \bar{L}, \bar{I}, \bar{R}) = (N, 0, 0, 0)$$

- ▶ Mass action incidence (frequency-dependent contacts):

$$f_I^* = \beta \bar{S} \Rightarrow \mathcal{R}_0 = \frac{\epsilon \beta N}{(\epsilon + d)(\gamma + d)}$$

- ▶ Standard incidence (proportion-dependent contacts):

$$f_I^* = \frac{\beta \bar{S}}{N} \Rightarrow \mathcal{R}_0 = \frac{\epsilon \beta}{(\epsilon + d)(\gamma + d)}$$

Links between SLIRS-type models

$$S' = b + \nu R - dS - f(S, I, N)$$

$$L' = f(S, I, N) - (d + \varepsilon)L$$

$$I' = \varepsilon L - (d + \gamma)I$$

$$R' = \gamma I - (d + \nu)R$$

SLIR	SLIRS where $\nu = 0$
SLIS	Limit of SLIRS when $\nu \rightarrow \infty$
SLI	SLIR where $\gamma = 0$
SIRS	Limit of SLIRS when $\varepsilon \rightarrow \infty$
SIR	SIRS where $\nu = 0$
SIS	Limit of SIRS when $\nu \rightarrow \infty$
	Limit SLIS when $\varepsilon \rightarrow \infty$
SI	SIS where $\nu = 0$

Values of \mathcal{R}_0

$(\bar{S}, \bar{I}, \bar{N})$ values of S, I and N at DFE. Denote $\bar{f}_I = \partial f / \partial I(\bar{S}, \bar{I}, \bar{N})$.

SLIRS	$\frac{\varepsilon \bar{f}_I}{(d+\varepsilon)(d+\gamma)}$
SLIR	$\frac{\varepsilon \bar{f}_I}{(d+\varepsilon)(d+\gamma)}$
SLIS	$\frac{\varepsilon \bar{f}_I}{(d+\varepsilon)(d+\gamma)}$
SLI	$\frac{\varepsilon \bar{f}_I}{(d+\varepsilon)(d+\gamma)}$
SIRS	$\frac{\varepsilon \bar{f}_I}{d+\gamma}$
SIR	$\frac{\bar{f}_I}{d+\gamma}$
SIS	$\frac{\bar{f}_I}{d+\gamma}$
SI	$\frac{\bar{f}_I}{d+\gamma}$

The SLIRS models and friends

- SIS models

- SLIRS model with constant population

- Computing \mathcal{R}_0 more efficiently

- Global properties of the SLIRS model

- SLIRS in variable population

- A better vaccination model

Mathematical Medicine and Biology (2004) **21**, 75–83

**Lyapunov functions and global properties for *SEIR* and
SEIS epidemic models**

ANDREI KORUBEINIKOV†

*Centre for Mathematical Biology, Mathematical Institute, University of Oxford,
24–29 St Giles', Oxford OX1 3LB, UK*

[Received on 16 May 2003; revised on 10 December 2003]

Lyapunov function for SLIR and SLIS

Consider an SLIR in constant population (normed to 1), with vertical transmission

$$S' = d - \beta SI - pdI - qdL - dS \quad (13a)$$

$$L' = \beta SI + pdI - (\varepsilon + d - qd)L \quad (13b)$$

$$I' = \varepsilon L - (\gamma + d)I \quad (13c)$$

p proportion of progeny of I that are I at birth, q proportion of progeny of L that are L at birth

R does not play a role in the dynamics of (13), it is not shown

Equilibria

- ▶ DFE: $\mathbf{E}_0 = (1, 0, 0)$.
- ▶ EEP: $\mathbf{E}_* = (S^*, L^*, I^*)$ with

$$S^* = \frac{1}{\mathcal{R}_0^V} \quad L^* = \frac{d}{\varepsilon + d} \left(1 - \frac{1}{\mathcal{R}_0^V}\right) \quad I^* = \frac{d\varepsilon}{(\varepsilon + d)(\gamma + d)} \left(1 - \frac{1}{\mathcal{R}_0^V}\right)$$

where

$$\mathcal{R}_0^V = \frac{\beta\varepsilon}{(\gamma + d)(\varepsilon + d) - qd(\varepsilon + d) - pd\varepsilon}$$

is the basic reproduction number with vertical transmission

We have $\mathcal{R}_0 = \mathcal{R}_0^V \iff p = q = 0$ or $\mathcal{R}_0^V = \mathcal{R}_0 = 1$

\mathbf{E}_* exists (in a biologically plausible way) only when $\mathcal{R}_0^V > 1$

Consider the Goh Lyapunov function

$$V = \sum a_i(x_i - x_i^* \ln x_i)$$

Theorem 5

- ▶ *If $\mathcal{R}_0 > 1$, then (13) has the globally asymptotically stable equilibrium \mathbf{E}_**
- ▶ *If $\mathcal{R}_0 \leq 1$, then (13) has the globally asymptotically stable equilibrium \mathbf{E}_0 , \mathbf{E}_* is not biologically plausible*

CANADIAN APPLIED
MATHEMATICS QUARTERLY
Volume 7, Number 4, Winter 1999

**GLOBAL STABILITY OF
SEIRS MODELS IN EPIDEMIOLOGY**

MICHAEL Y. LI, JAMES S. MULDOWNNEY AND P. VAN DEN DRIESSCHE

Li, Muldowney and van den Driessche

Study an SLIRS model with incidence of the form

$$f(S, I, N) = \beta g(I)S \quad (14)$$

where g is such that $g(0) = 0$, $g(I) > 0$ for $I \in (0, 1]$ and $g \in C^1(0, 1]$

They normalise the total population, so that $S + L + I + R = 1$

They make the following assumption about g :

$$(H) \quad c = \lim_{I \rightarrow 0^+} \frac{g(I)}{I} \leq +\infty; \text{ when } 0 < c < +\infty, \quad g(I) \leq cI \\ \text{for all sufficiently small } I$$

We have

$$\frac{\partial \bar{f}}{\partial l} = \beta \frac{\partial \bar{g}}{\partial l}$$

$$\text{Since } \frac{\partial \bar{g}}{\partial l} = \lim_{l \rightarrow 0^+} \frac{g(l)}{l} = c,$$

$$\mathcal{R}_0 = \frac{c\beta\varepsilon}{(d+\varepsilon)(d+\gamma)}$$

The LAS results already established hold here, since (14) is a special case of the function f with which the results were obtained

The system is **uniformly persistent** if there exists $0 < \varepsilon_0 < 1$ s.t. any solution $(S(t), L(t), I(t), R(t))$ of (9) with initial condition $(S(0), L(0), I(0), R(0)) \in \overset{\circ}{\Gamma}$ satisfies

$$\begin{aligned} \liminf_{t \rightarrow \infty} S(t) &\geq \varepsilon_0, & \liminf_{t \rightarrow \infty} E(t) &\geq \varepsilon_0 \\ \liminf_{t \rightarrow \infty} I(t) &\geq \varepsilon_0, & \liminf_{t \rightarrow \infty} R(t) &\geq \varepsilon_0 \end{aligned} \quad (15)$$

Theorem 6

*If $g(I)$ satisfies hypothesis **(H)**, then (9) with incidence (14) is uniformly persistent iff $\mathcal{R}_0 > 1$*

Theorem 7

Suppose that incidence (14) satisfies **(H)** and that

$$|g'(I)|I \leq g(I) \text{ for } I \in (0, 1] \quad (16)$$

Suppose additionally that $\mathcal{R}_0 > 1$ and that one of the following conditions holds

$$\begin{aligned} \gamma\nu &< \varepsilon_0(\beta\eta_0 + \gamma + d)(\beta\eta_0 + \nu + d) \\ \varepsilon - \gamma - d &< \nu \end{aligned}$$

where

$$\eta_0 = \min_{I \in [\varepsilon_0, 1]} g(I) > 0$$

and ε_0 is defined by (15)

Then there are no closed rectifiable curve that is invariant under (9). Furthermore, every semi-trajectory of (9) in Γ converges to an EP

The SLIRS models and friends

- SIS models

- SLIRS model with constant population

- Computing \mathcal{R}_0 more efficiently

- Global properties of the SLIRS model

- SLIRS in variable population

- A better vaccination model

SIRS of the form

$$S' = B(N) - dS - f(S, I)I + \nu R \quad (17a)$$

$$I' = f(S, I)I - (d + \gamma)I \quad (17b)$$

$$R' = \gamma I - (d + \nu)R \quad (17c)$$

Authors discuss the general case of f differentiable and s.t.
 $f(0, I) = 0$ for all I and $\partial f / \partial S > 0$

They assume that the demographic component of the model, ruled by

$$N' = B(N) - dN$$

admits a stable EP

Using the fact that N has a stable EP, they reduce the system

After establishing generic conditions leading to the existence of a Hopf bifurcation, they study the system in more detail when incidence takes the form

$$f(S, I) = \beta I^{p-1} S^q$$

Liu & van den Driessche

Liu and van den Driessche consider an SLIS model and an SLIRS model in which the population is not constant and where the latent period depends on the number of infected individuals in the population

In the case of the SLIS model, the behaviour is not modified by this function

In the case where immunity is temporary (SLIRS), they find (numerically) a Hopf bifurcation

The SLIRS models and friends

- SIS models

- SLIRS model with constant population

- Computing \mathcal{R}_0 more efficiently

- Global properties of the SLIRS model

- SLIRS in variable population

- A better vaccination model

GLOBAL RESULTS FOR AN EPIDEMIC MODEL WITH VACCINATION THAT EXHIBITS BACKWARD BIFURCATION*

JULIEN ARINO[†], C. CONNELL MCCLUSKEY[†], AND P. VAN DEN DRIESSCHE[†]

Abstract. Vaccination of both newborns and susceptibles is included in a transmission model for a disease that confers immunity. The interplay of the vaccination strategy together with the vaccine efficacy and waning is studied. In particular, it is shown that a backward bifurcation leading to bistability can occur. Under mild parameter constraints, compound matrices are used to show that each orbit limits to an equilibrium. In the case of bistability, this global result requires a novel approach since there is no compact absorbing set.

Key words. epidemic model, vaccination, backward bifurcation, compound matrices, global dynamics

AMS subject classifications. 92D30, 34D23

DOI. 10.1137/S0036139902413829

SLIRS with vaccination

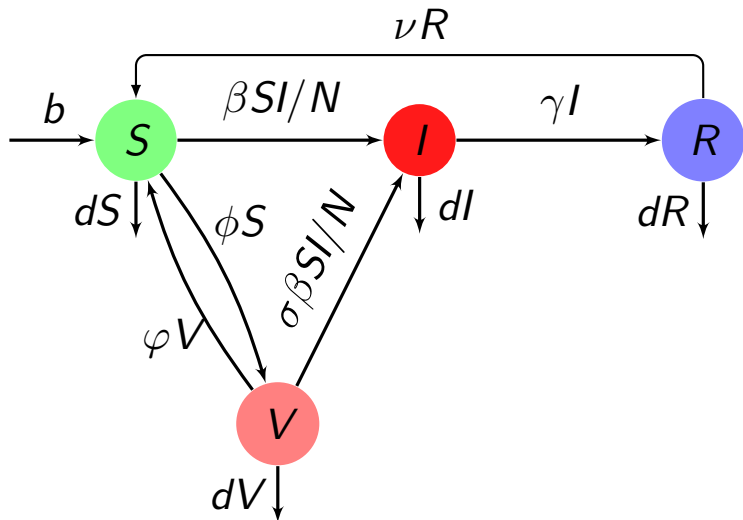

The usual situation

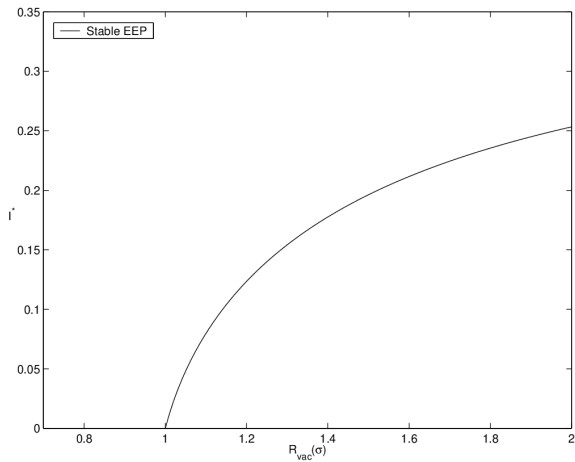

What can happen with vaccination – Backward bifurcation

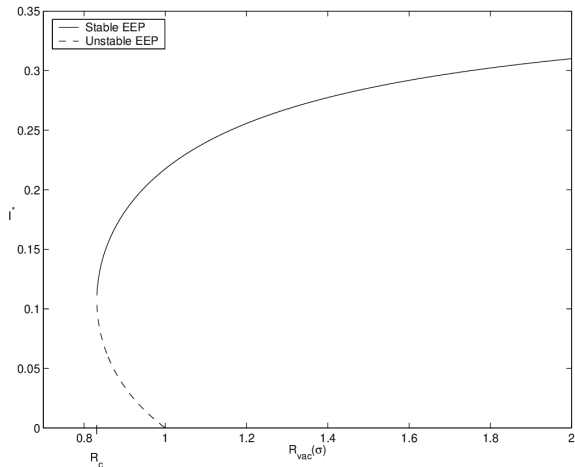

Extensions of the KMK model

The SLIRS models and friends

Vector-borne diseases

Immunology

A few other models

Something different – Discrete-time

Vector-borne diseases

Two Ross-Macdonald-type models

A little complexification of Ross-Macdonald

See, e.g., Simoy & Aparicio, Ross-Macdonald models: Which one should we use?, *Acta Tropica* (2020)

Ross introduced the model in 1911. Later “tweaked” by Macdonald to include mosquito latency period

Here, I show a version in the paper cited, with some notation changed

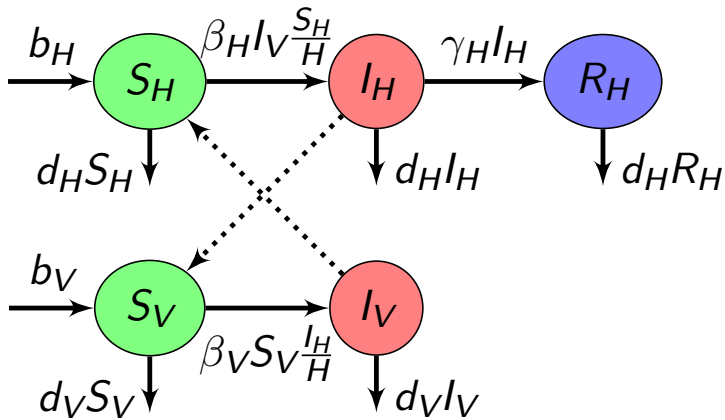

Reproduction number

$$\mathcal{R}_0 = \frac{\beta_H \beta_V}{(\gamma_H + \gamma_V) d_V} \frac{V^*}{H^*} \quad (18)$$

where H^* and V^* are the total host and vector populations, respectively

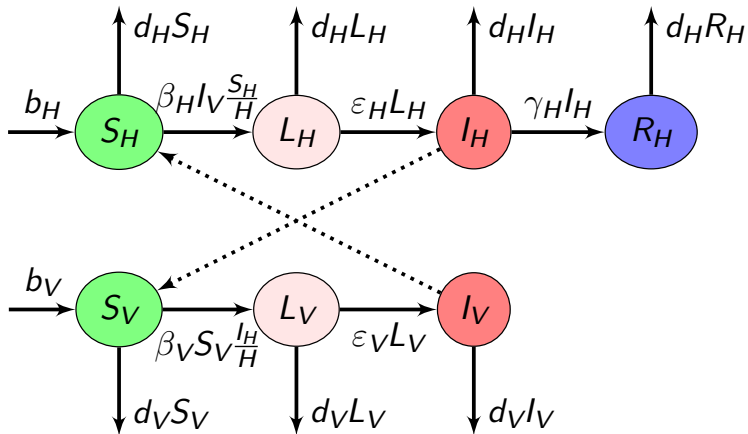

Reproduction number

$$\mathcal{R}_0 = \frac{\beta_H \beta_V}{(\gamma_H + \gamma_V) d_V} \frac{\varepsilon_V}{d_V + \varepsilon_V} \frac{\varepsilon_H}{d_H + \varepsilon_H} \frac{V^*}{H^*} \quad (19)$$

where H^* and V^* are the total host and vector populations, respectively

Here

$$f_X = \frac{\varepsilon_X}{d_X + \varepsilon_X}$$

are the fractions of latent individuals (of type $X = \{V, H\}$) who survive the latency period

Vector-borne diseases

Two Ross-Macdonald-type models

A little complexification of Ross-Macdonald

Recall this guy?

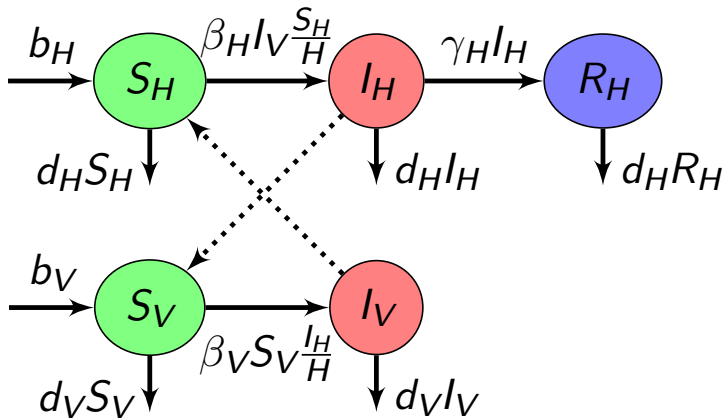

Let us add a few arrows

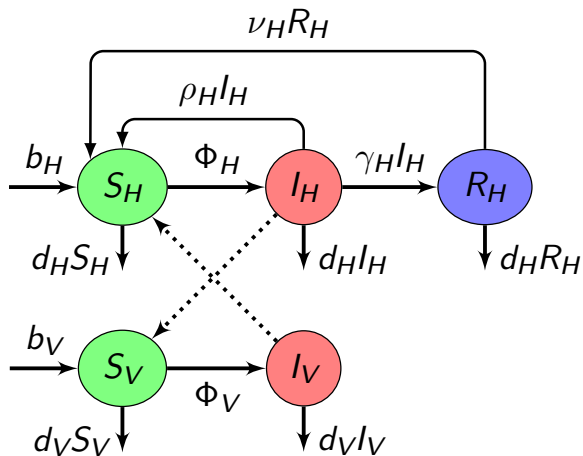

Arino, Ducrot & Zongo, A metapopulation model for malaria with transmission-blocking partial immunity in hosts, Journal of Mathematical Biology (2012)

Incidence functions take the form

$$\Phi_H = b_H(H, V)\sigma_{VH}\frac{I_V}{V}$$

and

$$\Phi_V = b_V(H, V) \left(\sigma_{HV}\frac{I_H}{H} + \hat{\sigma}_{HV}\frac{R_H}{H} \right)$$

where b_H and b_V are numbers per unit time of mosquito bites a human has and the number of humans a mosquito bites, respectively

Parameters of the incidence function

- ▶ σ_{HV} probability of transmission of the parasite (in gametocyte form) from an infectious human to a susceptible mosquito
- ▶ $\hat{\sigma}_{HV}$ probability of transmission of the parasite (in gametocyte form) from a semi-immune human to a susceptible mosquito
- ▶ σ_{VH} probability of transmission of the parasite (in sporozoite form) from an infectious mosquito to a susceptible human

Additional parameter that can be factored in (all per unit time)

- ▶ a_H maximum number of mosquito bites a human can receive
- ▶ a_V number of times one mosquito would “want to” bite humans
- ▶ a average number of bites given to humans by each mosquito

People to read for malaria models (IMOBO)

See also the work of

- ▶ Gideon Ngwa at the University of Buea

- ▶ Nakul Chitnis at the Swiss Tropical and Public Health Institute

Many others...

More complex models may be needed for malaria

Timing of processes is critical in malaria

Plasmodium life cycle in the mosquito is commensurate with mosquito lifetime

Need models that are able to account for that, because ODEs are not really good at this (see beginning of Stochastic systems lecture)

Mathematics becomes more complicated

Extensions of the KMK model

The SLIRS models and friends

Vector-borne diseases

Immunology

A few other models

Something different – Discrete-time

Caveat

I don't know much about this, this past year and a bit is the first time I have worked on this...

I recommend reading, e.g., Eftimie, Gillard & Cantrell, Mathematical Models for Immunology: Current State of the Art and Future Research Directions, *Bulletin of Mathematical Biology* (2016)

Look also at the work of Alan Perelson or read Wodarz's Killer Cell Dynamics (or here)

A simple model

State variables

- ▶ susceptible uninfected cells x
- ▶ infected cells y
- ▶ free virus v

$$x' = \lambda - dx - \beta xv$$

$$y' = \beta xv - ay$$

$$v' = ky - uv$$

Side note (a.k.a. little rank) – IMOBO don't do that

There is a tradition, typically stemming from the British modelling school, to use “random” letters for state variables

$$x' = \lambda - dx - \beta xv$$

$$y' = \beta xv - ay$$

$$v' = ky - uv$$

$$S' = \lambda - dS - \beta SV$$

$$I' = \beta SV - aI$$

$$V' = kI - uV$$

Modelling is hard enough without needing to recall what x , y , z , etc., stand for

$$S' = \lambda - dS - \beta SV \quad (20a)$$

$$I' = \beta SV - aI \quad (20b)$$

$$V' = kI - uV \quad (20c)$$

Virus-free equilibrium (VFE) $\mathbf{E}_0 = (\lambda/d, 0, 0)$ and establishment of infection

$$\mathbf{E}_* = \left(\frac{au}{\beta k}, \frac{\lambda\beta k - dau}{a\beta k}, \frac{\lambda\beta k - dau}{a\beta u} \right)$$

$$\mathcal{R}_0 = \frac{\lambda\beta k}{dau}$$

Simplification

Free virus population has much faster dynamics than cells, so we can assume virus population is at a quasi-steady state $V = kl/u$

Model becomes

$$S' = \lambda - dS - \tilde{\beta}SI \quad (21a)$$

$$I' = \tilde{\beta}SI - aI \quad (21b)$$

$$(21c)$$

where

$$\tilde{\beta} = \frac{\beta k}{u}$$

Drop the tilde on β , then

$$\mathcal{R}_0 = \frac{\beta k}{da}$$

Incorporating CTL dynamics

CTL proliferate when stimulated by viral antigen

$$S' = \lambda - dS - \beta SI \quad (22a)$$

$$I' = \beta SI - aI - pIC \quad (22b)$$

$$C' = cIC - bC \quad (22c)$$

Assume $\mathcal{R}_0 > 1$, i.e., the virus can successfully establish itself

Then if $(\lambda/a - d/\beta)c < d$, the CTL response fails to become established and the system goes to $(\beta/K, \lambda/K - d/\beta, 0)$

If $(\lambda/a - d/\beta)c > d$, then the system converges to

$$\left(\frac{\lambda c}{dc + \beta b}, \frac{b}{c}, \frac{(\beta \lambda - ad)c - ab\beta}{(cd + \beta b)p} \right)$$

Extensions of the KMK model

The SLIRS models and friends

Vector-borne diseases

Immunology

A few other models

Something different – Discrete-time

A few other models

- A model of Capasso for ETP

- A model for zoonotic transmission of waterborne disease

- A few models of schistosomiasis

A minimal model of V. Capasso

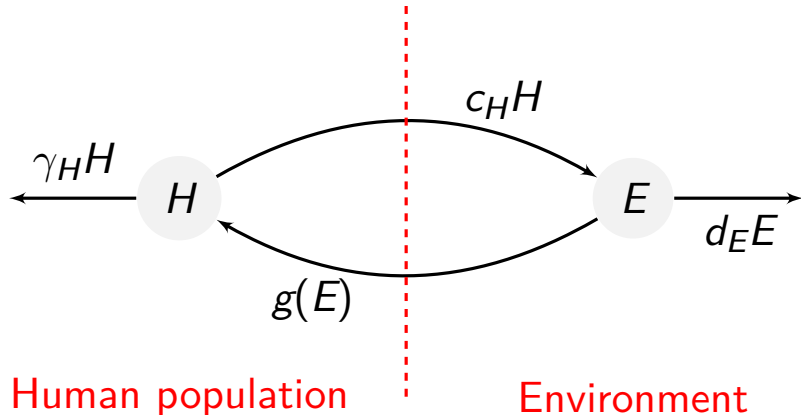

$1/\gamma_H$ mean infectious period, $1/d_E$ mean lifetime of the agent in the environment, c_H growth rate of the agent due to the human population, $g(E)$ "force of infection" (I would say "incidence") of the agent on human population

Incidence function

$$g(E) = N\beta ph(E) \quad (23)$$

where

- ▶ N total human population
- ▶ β fraction of susceptible individuals in N
- ▶ p fraction exposed to contaminated environment per unit time (“probability per unit time to have a “snack” of contaminated food”)
- ▶ $h(E)$ probability for an exposed susceptible to get the infection

Typically, we would assume p and β independent of E and H and h to be saturating

To ensure (23) satisfies these conditions, we can assume

- ▶ $0 < g(e_1) < g(e_2)$ for $0 < e_1 < e_2$
- ▶ $g(0) = 0$
- ▶ $g''(z) < 0$ for all $z > 0$
- ▶ $0 < g'_+(0) < \infty$ (right derivative)
- ▶ $\lim_{z \rightarrow \infty} \frac{g(z)}{z} < \frac{d_E \gamma_H}{c_H}$

Of course, we also assume $d_E, c_H, \gamma_H > 0$

The model

$$E' = c_H H - d_E E \quad (24a)$$

$$H' = g(E) - \gamma_H H \quad (24b)$$

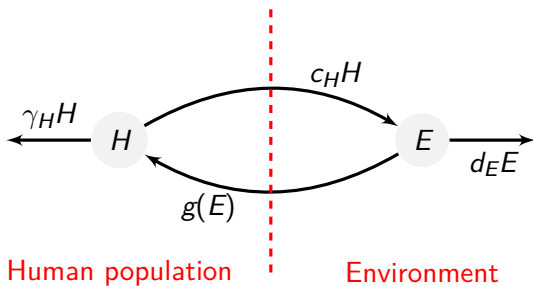

Pay attention to the flows..! E' does not have a $-g(E)$ and H' does not have $-c_H H$. Why?

Let

$$\mathcal{R}_0 = \frac{g'_+(0)c_H}{d_{E\gamma H}} \quad (25)$$

Theorem 8

- ▶ If $0 < \mathcal{R}_0 < 1$, then (24) admits only the trivial equilibrium in the positive orthant, which is GAS
- ▶ If $\mathcal{R}_0 > 1$, then two EP exist: $(0, 0)$, which is unstable, and $z^* = (E^*, H^*)$ with $E^*, H^* > 0$, GAS in $\mathbb{R}_+^2 \setminus \{0, 0\}$

Adding a periodic component

Assume p in (23) takes the form

$$p(t) = p(t + \omega) > 0, \quad t \in \mathbb{R} \quad (26)$$

i.e., p has period ω . So we now consider the incidence

$$g(t, E) = p(t)h(E) \quad (27)$$

with h having the properties prescribed earlier. Letting

$$p_{min} := \min_{0 \leq t \leq \omega} p(t), \quad p_{max} := \max_{0 \leq t \leq \omega} p(t) \quad (28)$$

then we require that

$$\lim_{z \rightarrow \infty} \frac{g(z)}{z} < \frac{d_E \gamma H}{c_H p_{max}} \quad (29)$$

Let

$$\mathcal{R}_0^{\min} = \frac{c_{HP_{\min}} h'_+(0)}{d_E \gamma_H}, \quad \mathcal{R}_0^{\max} = \frac{c_{HP_{\max}} h'_+(0)}{d_E \gamma_H} \quad (30)$$

Theorem 9

- ▶ *If $0 < \mathcal{R}_0^{\max} < 1$, then (24) with incidence (27) always goes to extinction*
- ▶ *If $\mathcal{R}_0^{\min} > 1$, then a unique nontrivial periodic endemic state exists for (24) with incidence (27)*

Simulating (in R) – Incidence function

```
h = function(E, params) {  
  # Use Michaelis Menten (Holling type II) growth  
  OUT = params$g_max * E / (params$g_half+E)  
  return(OUT)  
}  
g = function(E, params) {  
  OUT = params$N * params$beta * params$p * h(E,params)  
  return(OUT)  
}
```

The right hand side

```
rhs_Capasso_ODE = function(t, x, params) {  
  with(as.list(c(x, params)), {  
    dE = c_H*H-d_E*E  
    dH = g(E, params)-gamma_H*H  
    list(c(dE, dH))  
  })  
}
```

Setting parameters

```
# Put parameters in a list
params = list()
params$N = 1000      # Total population
params$gamma_H = 1/10 # Infectious period
params$d_E = 1/5     # Lifetime agent
params$c_H = 0.1     # Flow from humans
# Human characteristics and behaviour
params$beta = 0.2    # Fraction susceptible
params$p = 0.1      # Probability of having "snack"
# Growth function
params$g_max = 10
params$g_half = 100
# Final time
params$t_f = 150
```

Running and plotting (base)

```
IC <- c(E = 10, H = 0)
tspan = seq(from = 0, to = params$t_f, by = 0.1)

sol_ODE = ode(y = IC,
              func = rhs_Capasso_ODE,
              times = tspan,
              parms = params)

plot(sol_ODE[, "time"], sol_ODE[, "H"],
     type = "l", lwd = 2,
     xlab = "Time (days)", ylab = "Value")
lines(sol_ODE[, "time"], sol_ODE[, "E"],
      lwd = 2, lty = 3)
legend("bottomright", legend = c("H(t)", "E(t)"),
      lwd = c(2,2), lty = c(1,3), inset = 0.01)
```

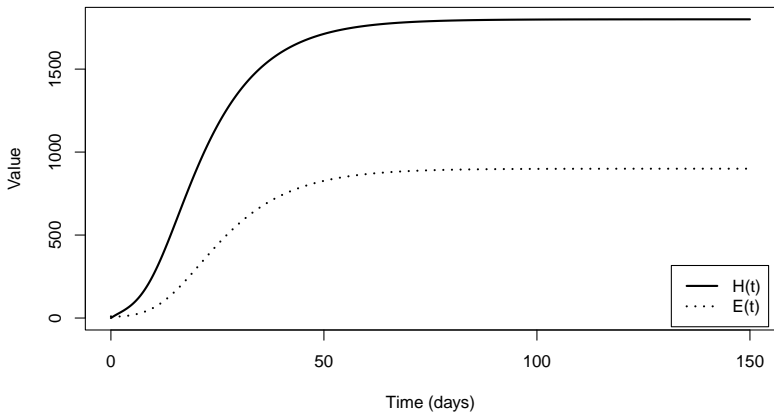

Let

$$\mathcal{R}_0 = \frac{g'_+(0)c_H}{d_{E\gamma H}} \quad (25)$$

Theorem 10

- ▶ If $0 < \mathcal{R}_0 < 1$, then (24) admits only the trivial equilibrium in the positive orthant, which is GAS
- ▶ If $\mathcal{R}_0 > 1$, then two EP exist: $(0, 0)$, which is unstable, and $z^* = (E^*, H^*)$ with $E^*, H^* > 0$, GAS in $\mathbb{R}_+^2 \setminus \{0, 0\}$

Computing \mathcal{R}_0

With the chosen g , we have

$$g'(E) = \frac{N\beta p g_{half} g_{max}}{(g_{half} + E)^2}$$

whence

$$g'_+(0) = \frac{N\beta p g_{max}}{g_{half}}$$

and thus

$$\mathcal{R}_0 = \frac{N\beta p g_{max}}{g_{half}} \frac{c_H}{d_E \gamma_H} \quad (31)$$

```
R0 = function(params) {  
  with(as.list(params), {  
    R0 = N*beta*p*g_max*c_H / (g_half*d_E*gamma_H)  
    return(R0)  
  })  
}
```

Showing things dynamically using Shiny

Shiny is an R library (made by RStudio) to easily make interactive displays

See some documentation [here](#)

Some examples [here](#) and [here](#)

Create a subdirectory with the name of your app and a file called `app.R` in there

Structure of a Shiny app

Need to use library shiny

Define two elements

- ▶ `ui`, which sets up the user interface
- ▶ `server`, which handles the computations, generation of figures, etc.

I explain different elements as we progress. See the code in the `CODE` folder and `Capasso_simpleETP_shiny` subdirectory

The ui part

Here, we use `fluidPage` to create the UI. There are other functions: `fillPage`, `fixedPage`, `flowLayout`, `navbarPage`, `sidebarLayout`, `splitLayout` and `verticalLayout`

```
# Define UI
ui <- fluidPage(
)
```

We now fill this function

A title and some sliders

```
# Application title
titlePanel("Simple ETP model of Capasso"),
# Sidebar with slider inputs for some parameters
sidebarLayout(
  sidebarPanel(
    sliderInput("inv_gamma_H",
               "Average infectious period (days):",
               min = 0,
               max = 30,
               value = 10),
    sliderInput("c_H",
               "Flow from humans:",
               min = 0,
               max = 2,
               value = 0.1),
```

Plus other sliders for all other parameters

Note the little trick...

```
sliderInput("inv_gamma_H",  
"Average infectious period (days):",  
min = 0,  
max = 30,  
value = 10),
```

I want to give a user friendly version of the parameter value, using the number of days rather than the inverse, whereas the model uses the latter. So I prefix the variable name by `inv_` and then process as follows in the server part

```
params <- list()  
for (param_name in names(input)) {  
  if (grepl("inv_", param_name)) {  
    new_param_name = gsubs("inv_", "", param_name)  
    params[[new_param_name]] = 1/input[[param_name]]  
  } else {  
    params[[param_name]] = input[[param_name]]  
  }  
}
```

The simulation functions can be outside of `ui` or `server`, this makes the code neater

These functions are the same as before (right hand side, `g`, `h`, `R0`), so they are not shown here

The server part

```
# Define server logic required to draw the result
server <- function(input, output) {
  ##
  ## Expression that generates the plot
  ##
  output$a_odePlot <- renderPlot({
    params <- list()
    params$N = 1000 # We could let this vary, we don't here..
    for (param_name in names(input)) {
      if (grepl("inv_", param_name)) {
        new_param_name = gsub("inv_", "", param_name)
        params[[new_param_name]] = 1/input[[param_name]]
      } else {
        params[[param_name]] = input[[param_name]]
      }
    }
  })
  ## Initial conditions and time span
  IC <- c(E = 10, H = 0)
  tspan <- seq(from = 0, to = params$tf, by = 0.1)
```

The server part (continued)

```
# Compute solution
sol_ODE = ode(y = IC,
              func = rhs_Capasso_ODE,
              times = tspan,
              parms = params)

# Make the plot
y_max = max(max(sol_ODE[, "H"]), sol_ODE[, "E"])
plot(sol_ODE[, "time"], sol_ODE[, "H"],
     type = "l", lwd = 2,
     xlab = "Time (days)", ylab = "Value",
     ylim = c(0, y_max),
     main = sprintf("R_0=%1.2f", round(R0(params), 2)))
lines(sol_ODE[, "time"], sol_ODE[, "E"],
      lwd = 2, lty = 3)
legend("topleft", legend = c("H(t)", "E(t)"),
      lwd = c(2, 2), lty = c(1, 3), inset = 0.01
    )
}
```

Finally, run the code

```
# Run the application  
shinyApp(ui = ui, server = server)
```

Adding a periodic component

Assume p in (23) takes the form

$$p(t) = p(t + \omega) > 0, \quad t \in \mathbb{R} \quad (32)$$

i.e., p has period ω . So we now consider the incidence

$$g(t, E) = p(t)h(E) \quad (27)$$

with h having the properties prescribed earlier. Letting

$$p_{min} := \min_{0 \leq t \leq \omega} p(t), \quad p_{max} := \max_{0 \leq t \leq \omega} p(t) \quad (33)$$

then we require that

$$\lim_{z \rightarrow \infty} \frac{g(z)}{z} < \frac{d_E \gamma H}{c_H p_{max}} \quad (34)$$

Let

$$\mathcal{R}_0^{\min} = \frac{cHP_{\min}h'_+(0)}{dE\gamma_H}, \quad \mathcal{R}_0^{\max} = \frac{cHP_{\max}h'_+(0)}{dE\gamma_H} \quad (30)$$

Theorem 11

- ▶ *If $0 < \mathcal{R}_0^{\max} < 1$, then (24) with incidence (27) always goes to extinction*
- ▶ *If $\mathcal{R}_0^{\min} > 1$, then a unique nontrivial periodic endemic state exists for (24) with incidence (27)*

How to add periodicity in numerics?

```
p_t = function(t, params) {  
  angle = 2*pi/params$p_period  
  OUT = cos(angle*t) # Make the base cos wave  
  OUT = OUT/2*(params$p_max-params$p_min) # Scale  
  OUT = OUT-min(OUT)+params$p_min # Shift up  
  return(OUT)  
}  
g = function(E, params, t) {  
  OUT = params$N * params$beta * p_t(t, params) * h(E,params)  
  return(OUT)  
}  
R0 = function(params) {  
  with(as.list(params), {  
    R0 = list()  
    R0$min = N*beta*p_min*g_max*c_H / (g_half*d_E*gamma_H)  
    R0$max = N*beta*p_max*g_max*c_H / (g_half*d_E*gamma_H)  
    return(R0)  
  })  
}
```

A few other models

- A model of Capasso for ETP

- A model for zoonotic transmission of waterborne disease

- A few models of schistosomiasis

Zoonotic transmission of waterborne disease

Waters, Hamilton, Sidhu, Sidhu & Dunbar, Zoonotic transmission of waterborne disease: a mathematical model, *Bull Math Biol* (2016)

Used for instance to model *Giardia* transmission from possums to humans

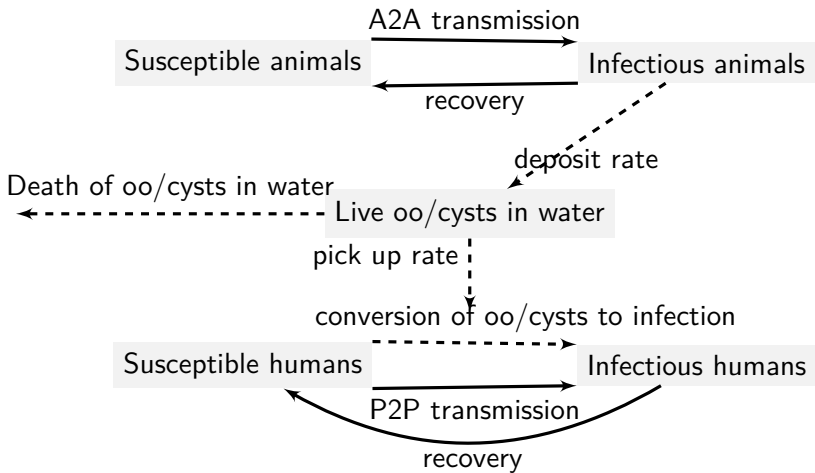

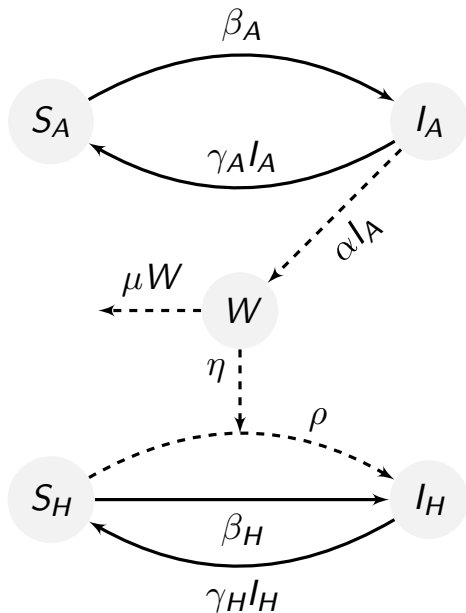

The full model

$$S_A' = -\beta_A S_A I_A + \gamma_A I_A \quad (35a)$$

$$I_A' = \beta_A S_A I_A - \gamma_A I_A \quad (35b)$$

$$W' = \alpha I_A - \eta W(S_H + I_H) - \mu W \quad (35c)$$

$$S_H' = -\rho \eta W S_H - \beta_H S_H I_H + \gamma_H I_H \quad (35d)$$

$$I_H' = \rho \eta W S_H + \beta_H S_H I_H - \gamma_H I_H \quad (35e)$$

Considered with $N_A = S_A + I_A$ and $N_H = S_H + I_H$ constant

Simplified model

Because N_A and N_H are constant, (35) can be simplified:

$$I_A' = \beta_A N_A I_A - \gamma_A I_A - \beta_A I_A^2 \quad (36a)$$

$$W' = \alpha I_A - \eta W N_H - \mu W \quad (36b)$$

$$I_H' = \rho \eta W (N_H - I_H) + \beta_H N_H I_H - \gamma_H I_H - \beta_H I_H^2 \quad (36c)$$

Three EP: DFE $(0, 0, 0)$; endemic disease in humans because of H2H transmission; endemic in both H and A because of W

Three EP: DFE $(0, 0, 0)$; endemic disease in humans because of H2H transmission; endemic in both H and A because of W

Let

$$\mathcal{R}_{0A} = \frac{\beta_A}{\gamma_A} N_A \quad \text{and} \quad \mathcal{R}_{0H} = \frac{\beta_H}{\gamma_H} N_H \quad (37)$$

- ▶ DFE LAS if $\mathcal{R}_{0A} < 1$ and $\mathcal{R}_{0H} < 1$, unstable if $\mathcal{R}_{0A} > 1$ or $\mathcal{R}_{0H} > 1$
- ▶ If $\mathcal{R}_{0H} > 1$ and $\mathcal{R}_{0A} < 1$, (36) goes to EP with endemicity only in humans
- ▶ Endemic EP with both A and H requires $\mathcal{R}_{0A} > 1$ and $\mathcal{R}_{0H} < 1$

Note that proof is **not** global

A few other models

A model of Capasso for ETP

A model for zoonotic transmission of waterborne disease

A few models of schistosomiasis

A few other models

A few models of schistosomiasis

A first model of Woolhouse

A second model of Woolhouse – Latency

A model of Woolhouse

Woolhouse. On the application of mathematical models of schistosome transmission dynamics. I. Natural transmission. *Acta Tropica* **49**:241-270 (1991)

The model

Population of H individuals using a body of water containing N snails

i_H mean number of schistosomes per person and i_S the proportion of patent infections in snails (prevalence)

$$i_H' = \alpha N i_S - \gamma i_H \quad (38a)$$

$$i_S' = \beta H i_H (1 - i_S) - \mu_2 i_S \quad (38b)$$

- ▶ α number of schistosomes produced per person per infected snail per unit time
- ▶ $1/\gamma$ average life expectancy of a schistosome
- ▶ $1/\mu_2$ average life expectancy of an infected snail
- ▶ β transmission parameter

Let the basic reproductive rate for schistosomes be

$$\mathcal{R}_0 = \frac{\alpha N \beta H}{\gamma \mu_2} \quad (39)$$

(38) has two EP

- ▶ $(i_H^*, i_S^*) = (0, 0)$, LAS when $\mathcal{R}_0 < 1$ and unstable when $\mathcal{R}_0 > 1$
- ▶ $(i_H^*, i_S^*) = \left(\frac{\alpha N}{\gamma} - \frac{\mu_2}{\beta H}, 1 - \frac{1}{\mathcal{R}_0} \right)$, which only “exists” when $\mathcal{R}_0 > 1$ (and is LAS then)

A few other models

A few models of schistosomiasis

A first model of Woolhouse

A second model of Woolhouse – Latency

Extending the model

Interval between infection of a snail and onset of patency (release of cercariae) is *prepatent* or *latent* period

$$i_H' = \alpha N i_S - \gamma i_H \quad (40a)$$

$$l_S' = \beta H i_H (1 - l_S - i_S) - \sigma l_S - \mu_1 l_S \quad (40b)$$

$$i_S' = \sigma l_S - \mu_2 i_S \quad (40c)$$

- ▶ $1/\sigma$ average duration of prepatent period
- ▶ $f = \sigma/(\sigma + \mu_1)$ fraction of infected snails surviving prepatent period

The basic reproductive rate for schistosomes is now

$$\mathcal{R}_0 = f \frac{\alpha N \beta H}{\gamma \mu_2} \quad (41)$$

(40) has endemic EP

$$(i_H^*, i_S^*) = \left(\frac{\alpha N \sigma}{\gamma(\sigma + \mu_2)} - \frac{\mu_2(\sigma + \mu_1)}{\beta H(\sigma + \mu_2)}, \frac{\sigma}{\sigma + \mu_2} \left(1 - \frac{1}{\mathcal{R}_0} \right) \right)$$

Also has models

- ▶ where snails lose infectiousness (assumed to happen sometimes)
- ▶ with larval population dynamics
- ▶ single variable models
- ▶ human immigration and emigration
- ▶ reservoir hosts

Really worth a read

Extensions of the KMK model

The SLIRS models and friends

Vector-borne diseases

Immunology

A few other models

Something different – Discrete-time

A tetanus model of Cvjetanović

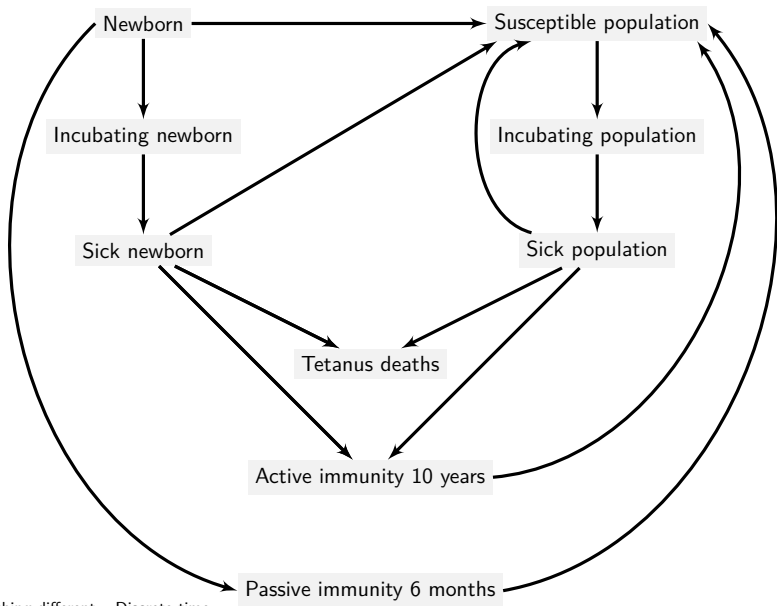

Flow diagram (demography not shown)

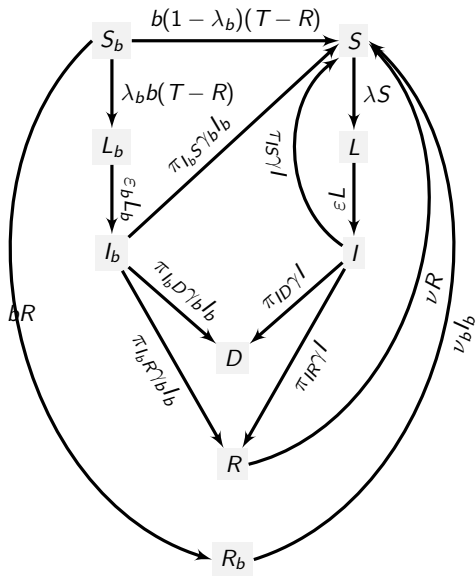

The discrete-time tetanus model (notation mine)

$$\Delta S_b = bT \quad (42a)$$

$$\Delta S = b(1 - \lambda_b)(T - R) + \nu R + \nu_b I_b + \nu I + \pi_{I_b S} \gamma_b I_b + \pi_{IS} \gamma I - (\lambda + d - \delta_T)S \quad (42b)$$

$$\Delta L_b = \lambda_b b(T - R) - (\varepsilon_b + d - \delta_T)L_b \quad (42c)$$

$$\Delta L = \lambda S - (\varepsilon + d - \delta_T)L \quad (42d)$$

$$\Delta I_b = \varepsilon_b L_b - (\gamma_b + d - \delta_T)I_b \quad (42e)$$

$$\Delta I = \varepsilon L - (\gamma + d - \delta_T)I \quad (42f)$$

$$\Delta R = \pi_{I_b R} \gamma_b I_b + \pi_{IR} \gamma I - (\nu + d - \delta_T)R \quad (42g)$$

$$\Delta R_b = bR - (\nu_b + d - \delta_T)R_b \quad (42h)$$

$$\Delta D = \pi_{I_b D} \gamma_b I_b + \pi_{ID} \gamma I \quad (42i)$$

where

$$T = S + L_b + L + I_b + I + R + R_b \quad \text{and} \quad \delta_T = \frac{\Delta D}{T} \quad (42j)$$

Parameter assumptions – Tetanus

- ▶ **Incubation period** – Mean duration 6 days for newborn and 8 days for general population \Rightarrow daily rate of exit (d.r.e.) $\varepsilon_b = 0.1667$ and $\varepsilon = 0.125$
- ▶ **Period of sickness** – Mean duration 3 days for newborn and 14 days for general population \Rightarrow d.r.e. $\gamma_b = 0.3333$ per sick newborn and $\gamma = 0.0714$ for sick general in general population
- ▶ **Mortality from tetanus** – Untreated tetanus cases, fatality rate 90% for newborn S_b and 40% for general population. Treated: 80% for newborn and 30% general population
- ▶ **Immunity** – Tetanus cases do not lead to immunity to reinfection. But as a general rule, recovered people are vaccinated. Convalescents and general population effectively immunised by complete course of vaccination go to R for average 10 years, d.r.e. $\nu = 0.000274$ per person.
- ▶ **Immunity of newborns** – Newborn to women vaccinated during pregnancy are temporarily protected by maternal antibodies and pass through R_b for a mean duration of 6 months. D.r.e. $\nu_b = 0.005479$ per immunised newborn

Deciding on infection outcome – π

Parameters π are proportion of individuals who follow a certain route post-infection

- ▶ π_{I_b} proportion of infected newborn who
 - ▶ π_{I_bS} recover without immunity
 - ▶ π_{I_bR} recover with immunity
 - ▶ π_{I_bD} die (0.9)

$$\pi_{I_bS} + \pi_{I_bR} + \pi_{I_bD} = 1$$

- ▶ π_I proportion of infected who
 - ▶ π_{IS} recover without immunity
 - ▶ π_{IR} recover with immunity
 - ▶ π_{ID} die (0.4)

$$\pi_{IS} + \pi_{IR} + \pi_{ID} = 1$$

Parameter assumptions – Demography

Live birth rate 35 per 1,000 population and annual crude death rate 15 per 1,000 population (annual rate of growth 2%) \Rightarrow daily birth and death rates $b = 0.00009889$ and $d = 0.0000411$ per person, respectively

Parameter assumptions – Force of infection

No H2H transmission \Rightarrow incidence proportional to number of susceptible individuals and force of infection, which quantifies combined effect of all variables involved in infection process:

- ▶ degree of soil contamination with *Clostridium tetani*
- ▶ climate
- ▶ frequency of lesions
- ▶ proportion of rural population
- ▶ socioeconomic conditions
- ▶ level of medical care for the wounded and during deliveries

Force of infection acting on newborn (λ_b) and susceptible population (λ) fixed at 3 different levels adequate for reproducing the following stable annual incidence rates of tetanus cases in the community

- ▶ For newborn, 200 cases, 400 cases and 600 cases per 100,000 newborn
- ▶ For general population (without newborn), 9, 18 and 27 cases

A crash course on discrete-time systems

We have seen systems of ordinary differential equations (ODE) of the form

$$\frac{d}{dt}x(t) = f(x(t))$$

often written omitting dependence on t , i.e.,

$$x' = f(x) \tag{43}$$

where $x \in \mathbb{R}^n$ and $f: \mathbb{R}^n \rightarrow \mathbb{R}^n$. The system is considered together with an initial condition $x(t_0) = x_0 \in \mathbb{R}^n$.

The **independent** variable $t \in \mathbb{R}$

A discrete-time system takes the form

$$x(t + \Delta t) = f(x(t)) \quad (44)$$

where $x(t) \in \mathbb{R}^n$ and $f: \mathbb{R}^n \rightarrow \mathbb{R}^n$

In a discrete-time system, t is discrete and can be assumed to be in \mathbb{Z} or \mathbb{N} (in practice, before “recasting”, it is in \mathbb{Q}), we often write $x(t + 1) = f(x(t))$, assuming $\Delta t = 1$.

Together with an initial condition $x(t_0) = x_0 \in \mathbb{R}^n$, this constitutes a sequence that describes the evolution of the state x

Similarities/differences

$$x' = f(x), x(t_0) = x_0, x \in \mathbb{R}^n$$

Equilibria (EP) x^* s.t. $f(x^*) = 0_{\mathbb{R}^n}$

$$\text{LAS EP} \Leftrightarrow s(Df(x^*)) < 0$$

$$x(t + \Delta t) = f(x(t)), x(t_0) = x_0, x \in \mathbb{R}^n$$

Fixed points (FP) x^* s.t. $f(x^*) = x^*$

$$\text{LAS FP} \Leftrightarrow \rho(Df(x^*)) < 1$$

Notation – if $A \in \mathcal{M}_n$ is a matrix,

$\text{Sp}(A) = \{\lambda \in \mathbb{C} : A\mathbf{v} = \lambda\mathbf{v}, \mathbf{v} \neq \mathbf{0}\}$ is its **spectrum**, i.e., the set of all its eigenvalues and

- ▶ $s(A) = \max\{\text{Re}(\lambda), \lambda \in \text{Sp}(A)\}$ is its **spectral abscissa**
- ▶ $\rho(A) = \max\{|\lambda|, \lambda \in \text{Sp}(A)\}$ is its **spectral radius**

Simulating the system

The R package we use for ODE (`deSolve`) can also do discrete-time systems, with very little adaptation..

The function call is then of the form

```
sol <- ode(func = tetanus_Cvjetanovic, y = IC, times = 0:30,  
          parms = params, method = "iteration")
```

From the help for `ode`

Method "iteration" is special in that here the function `func` should return the new value of the state variables rather than the rate of change

The right hand side

```
tetanus_Cvjetanovic = function(t, y, params) {  
  with(as.list(c(y, params)), {  
    T = S+L_b+L+I_b+I+R+R_b  
    dD = pi_IbD*gamma_b*I_b+pi_ID*gamma*I  
    delta_T = dD/T  
    dS_b = b*T  
    dS = b*(1-lambda_b)*(T-R)+nu*R+nu_b*I+pi_IbS*gamma_b*I_b +  
      pi_IS*gamma*I-(lambda+d-delta_T)*S  
    dL_b = lambda_b*b*(T-R)-(epsilon_b+d-delta_T)*L_b  
    dL = lambda*S-(epsilon+d-delta_T)*L  
    dI_b = epsilon_b*L_b-(gamma_b+d-delta_T)*I  
    dI = epsilon*L-(gamma+d-delta_T)*I  
    dR = pi_IbR*gamma_b*I_b+pi_IR*gamma*I-(nu+d-delta_T)*R  
    dR_b = b*R-(nu_b+d-delta_T)*R_b  
    list(c(S_b+dS_b,S+dS,L_b+dL_b,L+dL,I_b+dI_b,I+dI,R+dR,R_b+dR_b,  
          D+dD))  
  })  
}
```

Set parameters

```
params = list()
params$epsilon_b = 0.1667
params$epsilon = 0.125
params$gamma_b = 1/3
params$gamma = 0.0714
params$nu = 0.000274
params$nu_b = 0.005479
params$b = 0.00009889
params$d = 0.0000411

params$pi_IbS = 0.05
params$pi_IS = 0.3
params$pi_IbR = 0.05
params$pi_IR = 0.3
params$pi_IbD = 0.9
params$pi_ID = 0.4

params$lambda_b = 0.1
params$lambda = 0.1
```

A last few things then run

```
IC = c(S_b = 0,  
      S = 100000,  
      L_b = 0,  
      L = 0,  
      I_b = 0,  
      I = 0,  
      R = 0,  
      R_b = 0,  
      D = 0)  
tspan = 0:30  
sol <- ode(func = tetanus_Cvjetanovic, y = IC, times = tspan,  
          parms = params, method = "iteration")
```

A few remarks about this model

To set λ_b and λ , we need to explore numerically model response

Discrete-time models can be analysed in pretty much the same way as continuous time ones, but this one will be hard: there is no DFFP!

This means the usual methods for computing \mathcal{R}_0 will not work, as there is no DFFP to perturb away from...