



University
of Manitoba

Introduction to mathematical epidemiology

ICMS – Course 01

Julien Arino

University of Manitoba

julien.arino@umanitoba.ca

09 December 2024

The University of Manitoba campuses are located on original lands of Anishinaabeg, Inineew, Anisinineew, Dakota and Dene peoples, and on the National Homeland of the Red River Métis.

We respect the Treaties that were made on these territories, we acknowledge the harms and mistakes of the past, and we dedicate ourselves to move forward in partnership with Indigenous communities in a spirit of Reconciliation and collaboration.

Outline

Mathematical Epidemiology

Kermack-McKendrick-type epidemic models

Endemic SIRS-type models with demography

What if there's another guest at the party?

Last remarks





Mathematical Epidemiology

Kermack-McKendrick-type epidemic models

Endemic SIRS-type models with demography

What if there's another guest at the party?

Last remarks

Mathematical Epidemiology

Brief remarks about terminology

Mathematical epidemiology – The early years

Computational epidemiology

Use of data in mathematical epidemiology

Compartmental models

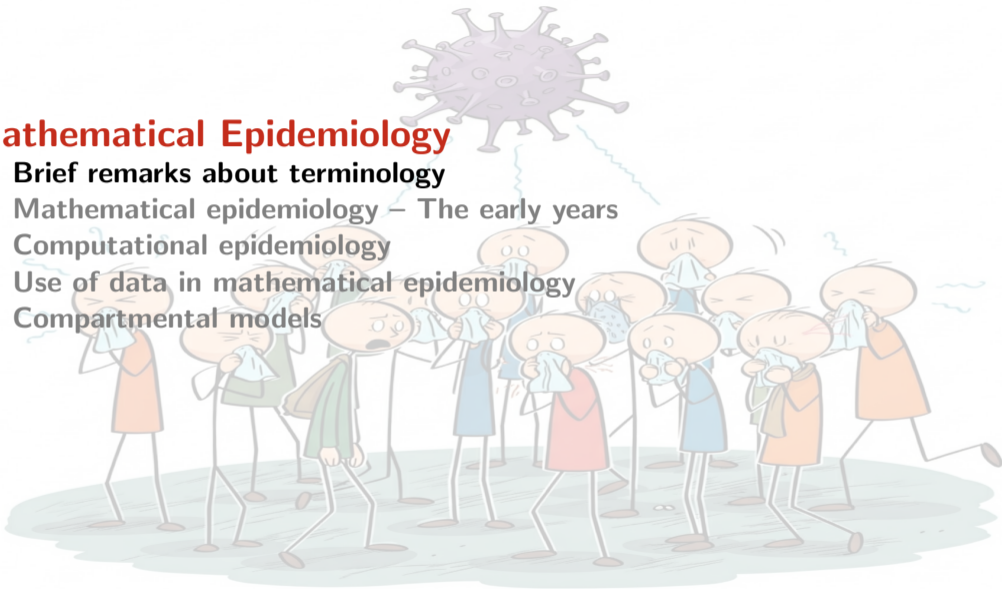



Toward Standardizing a Lexicon of Infectious Disease Modeling Terms

Rachael Milwid¹, Andreea Steriu², Julien Arino³, Jane Heffernan⁴, Ayaz Hyder⁵, Dena Schanzer⁶, Emma Gardner¹, Margaret Haworth-Brockman⁷, Harpa Isfeld-Kiely⁷, Joanne M. Langley⁸ and Seyed M. Moghadas^{9}*

¹Department of Population Medicine, University of Guelph, Guelph, ON, Canada, ²International Programmes, London School of Hygiene and Tropical Medicine, University of London, London, UK, ³Department of Mathematics, Centre for Disease Modelling, The University of Manitoba, Winnipeg, MB, Canada, ⁴Department of Mathematics and Statistics, Centre for Disease Modelling, York University, Toronto, ON, Canada, ⁵Division of Environmental Health Sciences, College of Public Health, The Ohio State University, Columbus, OH, USA, ⁶Public Health Agency of Canada, Ottawa, ON, Canada, ⁷National Collaborating Centre for Infectious Diseases, The University of Manitoba, Winnipeg, MB, Canada, ⁸Canadian Center for Vaccinology, Dalhousie University, IWK Health Centre and Nova Scotia Health Authority, Halifax, NS, Canada, ⁹Agent-Based Modelling Laboratory, York University, Toronto, ON, Canada

Incidence & Prevalence (when?)

Incidence: number of new cases in a population generated within a certain time period

Prevalence: number of cases of a disease at a single time point in a population

$\implies I(t)$ in an epidemiological model is **prevalence**, not **incidence**

Exposition versus Exposed

- Some bright bulb (not sure who) in days of yore: let's call **exposed** someone who has contracted the disease but is not yet showing symptoms (\implies SEIR model)
- "Real" epidemiologist: let's trace people who were exposed to the virus, i.e., people having come into contact with the virus (whether they have contracted the disease or not)
- Interestingly, I am embarked on a quixotic quest to make people use L instead of E , only to be told by real epidemiologists that they don't care :) (see this paper, though: Origins of the problematic E in SEIR epidemic models, D. Burke, IDM 2024)

Some terminology for “where”

- ▶ **Epidemic**: diseases that are *visited upon* a population
- ▶ **Pandemic**: epidemic that has spread across a large region, e.g., multiple continents or worldwide
- ▶ **Endemic**: disease that *resides within* a population
- ▶ We don't say “panendemic”

The different stages of propagation

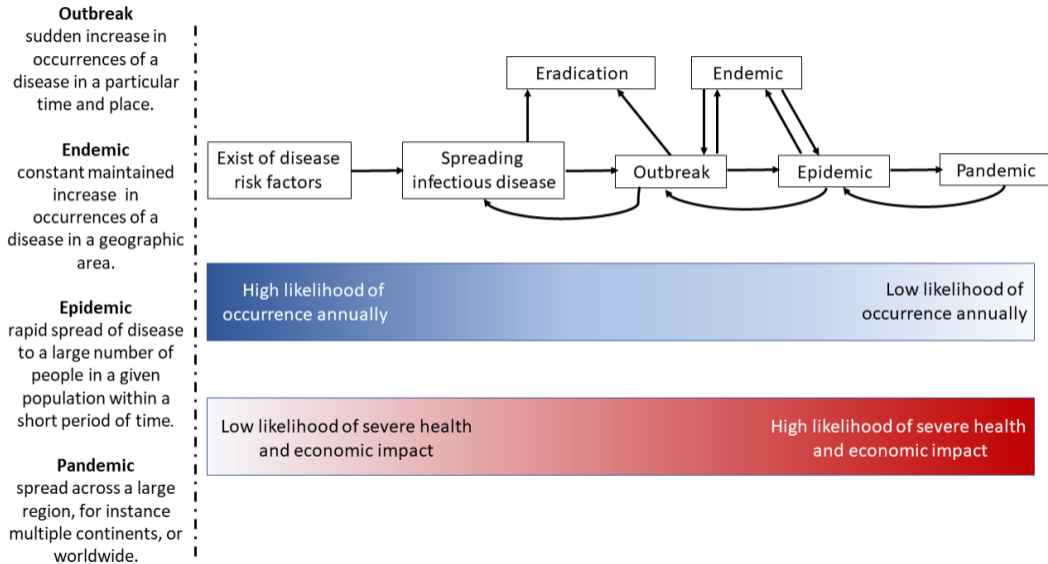

Mathematical Epidemiology

Brief remarks about terminology

Mathematical epidemiology – The early years

Computational epidemiology

Use of data in mathematical epidemiology

Compartmental models

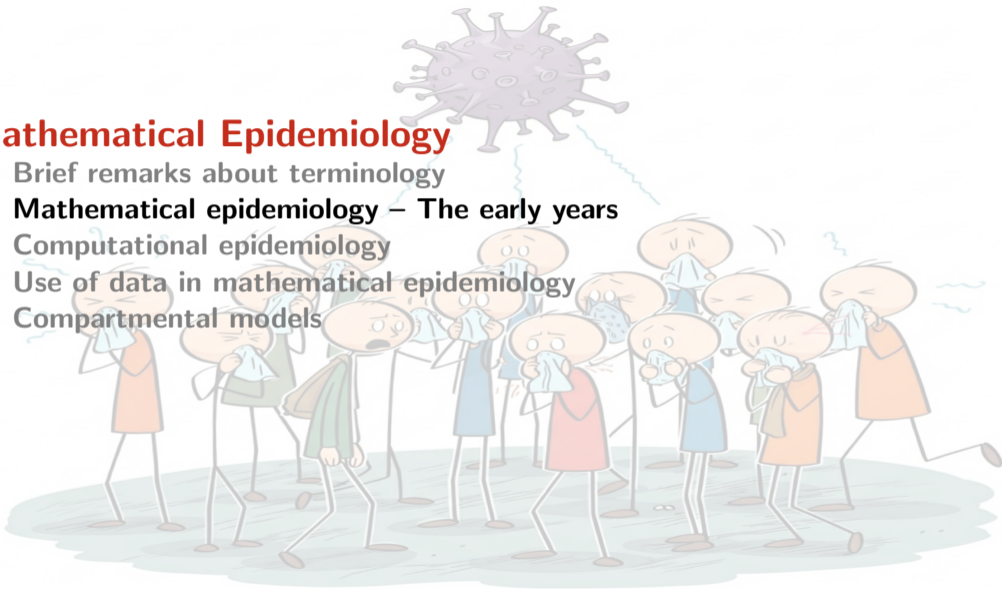

Daniel Bernoulli (1760)

- ▶ BNF scan or pdf
- ▶ Probably the first epidemic model
- ▶ About petite vérole (smallpox) inoculation

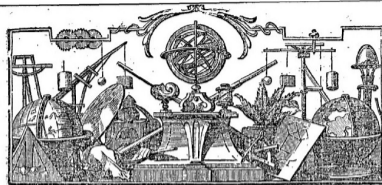

M É M O I R E S

DE

MATHÉMATIQUE

ET

DE PHYSIQUE,

TIRÉS DES REGISTRES

de l'Académie Royale des Sciences;

De l'Année M. DCCLX.

ESSAI D'UNE NOUVELLE ANALYSE

De la mortalité causée par la petite Vérole, & des avantages de l'Inoculation pour la prévenir.

Par M. DANIEL BERNOULLI.

INTRODUCTION APOLOGÉTIQUE*.

C E U X qui ont senti tout l'avantage de l'Inoculation, ont imaginé différentes façons de représenter cet avantage, qui, quoique revenant au même, ne laissent pas de faire une

* Cette Introduction n'a été faite que long-temps après le Mémoire, étant du 16 Avril 1765.

Mémoires.

A

Ross (early 1900)

- ▶ On 20 August 1897, observed malaria parasites in the gut of a mosquito fed several days earlier on a malaria positive human
- ▶ Nobel Prize for Medicine 1902
- ▶ Started considering malaria eradication using mathematical models; for some history, read this 2012 paper



Kermack and McKendrick (1927+)

Model in these slides is a particular case in

- ▶ Kermack & McKendrick. A contribution to the mathematical theory of epidemics (1927)

That paper was followed by a series of “Contributions to the mathematical theory of epidemics.”

- ▶ II. The problem of endemicity (1932)
- ▶ III. Further studies of the problem of endemicity (1933)
- ▶ IV. Analysis of experimental epidemics of the virus disease mouse ectromelia (1937)
- ▶ V. Analysis of experimental epidemics of mouse-typhoid; a bacterial disease conferring incomplete immunity (1939)

Macdonald, Dietz and malaria

- ▶ Read for instance this paper, which presents a history of the development of the so-called Ross-Macdonald model

- ▶ Klaus Dietz also worked a lot on malaria

Some activity later, but not much until 1990s

- ▶ In recent years, explosion

- ▶ Since the beginning of COVID-19: just nuts..

Some landmarks in mathematical epidemiology (IMBO)

- ▶ Macdonald. The epidemiology and control of malaria. 1957
- ▶ Baroyan, Rvachev et al. Deterministic epidemic models for a territory with a transport network. Kibernetika, 1967
- ▶ Hethcote & Yorke. Gonorrhea Transmission Dynamics and Control. LNBM 56, 1984
- ▶ Anderson & May. Infectious diseases of humans: dynamics and control. 1991
- ▶ Capasso. Mathematical Structures of Epidemic Systems. LNBM 97, 1993
- ▶ Hethcote. The mathematics of infectious diseases. SIAM Review, 2000
- ▶ van den Driessche & Watmough. Reproduction numbers and sub-threshold endemic equilibria for compartmental models of disease transmission. MBS, 2002

Mathematical Epidemiology

Brief remarks about terminology

Mathematical epidemiology – The early years

Computational epidemiology

Use of data in mathematical epidemiology

Compartmental models

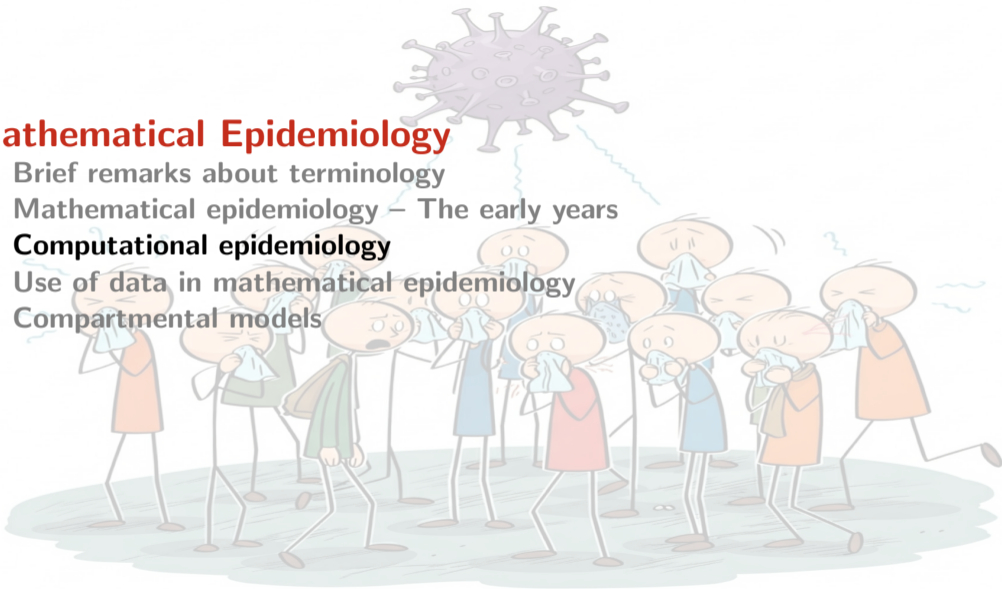

A more recent trend

- ▶ Some rare numerical work \leq 1980s, mostly simulation of math models
 - ▶ Baroyan, Rvachev et al. Computer modelling of influenza epidemics for the whole country (USSR). *Advances in Applied Probability* (1971)
 - ▶ Rvachev & Longini. A mathematical model for the global spread of influenza. *Mathematical Biosciences* (1986)
 - ▶ Flahault, Letrait et al. Modelling the 1985 influenza epidemic in France. *Statistics in Medicine* (1988)

- ▶ More and more frequent now, to the point that some modelling studies are purely simulation-based

Agent-based models (ABM)

- ▶ Early in the life of these models, they were called IBM (individual-based models)
- ▶ Over the years, a "philosophical" distinction has emerged:
 - ▶ IBM are mathematical models that consider individuals as the units; e.g., DTMC, CTMC, branching processes, etc.
 - ▶ ABM are computational models whose study is, for the most part, only possible numerically

Network models

- ▶ Network models endow vertices with simple systems and couple them through graphs

- ▶ Can be ABM, but some networks can also be studied analytically

Mathematical Epidemiology

Brief remarks about terminology

Mathematical epidemiology – The early years

Computational epidemiology

Use of data in mathematical epidemiology

Compartmental models



Has happened all along, undergoing a transformation

- ▶ Epidemiology has long relied on data
- ▶ Many developments in statistics originate there
- ▶ Data has traditionally been better for chronic diseases than for infectious ones
- ▶ Near-real-time surveillance of infectious diseases ongoing since the 1980s (e.g., Réseau Sentinelles)
- ▶ SARS-CoV-1 saw the beginning of a move towards real-time emerging infectious disease data
- ▶ With SARS-CoV-2, the system has really progressed a lot, both in terms of “citizen science” and governmental initiatives



Mathematical Epidemiology

Brief remarks about terminology

Mathematical epidemiology – The early years

Computational epidemiology

Use of data in mathematical epidemiology

Compartmental models

Compartmental models

- ▶ Have become synonymous with epidemiological models
- ▶ Many epidemiological models are compartmental models, but the development of compartmental models in the 1970-1980s was not at all specific to epidemiology
- ▶ See in particular the works of John Jacquez, Carl Simon, GG Walter
- ▶ Unjustly fell into disuse: there are some very nice results in the area

Compartment (Jacquez 1979)

A **compartment** is an amount of some material which acts kinetically like a distinct, homogeneous, well-mixed amount of material. A **compartmental system** consists of one or more compartments which interact by exchanging the material. There may be inputs into one or more compartments from outside the system and there may be excretions from the compartments of the system.

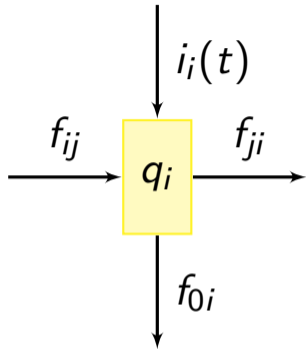

- ▶ q_i size of the compartment, i.e., quantity of kinetically homogeneous material present in i ; $q_i \geq 0$
- ▶ f_{ij} and f_{ji} transfer coefficients/functions
- ▶ f_{0i} excretion coefficient/function
- ▶ $i_i(t)$ entries from outside the system

Above is a **flow diagram**, which summarises the different flows acting on the compartment



Mathematical Epidemiology

Kermack-McKendrick-type epidemic models

Endemic SIRS-type models with demography

What if there's another guest at the party?

Last remarks

A Contribution to the Mathematical Theory of Epidemics.

By W. O. KERMACK and A. G. MCKENDRICK.

(Communicated by Sir Gilbert Walker, F.R.S.—Received May 13, 1927.)

(From the Laboratory of the Royal College of Physicians, Edinburgh.)

Introduction.

(1) One of the most striking features in the study of epidemics is the difficulty of finding a causal factor which appears to be adequate to account for the magnitude of the frequent epidemics of disease which visit almost every population. It was with a view to obtaining more insight regarding the effects of the various factors which govern the spread of contagious epidemics that the present investigation was undertaken. Reference may here be made to the work of Ross and Hudson (1915–17) in which the same problem is attacked. The problem is here carried to a further stage, and it is considered from a point of view which is in one sense more general. The problem may be summarised as follows: One (or more) infected person is introduced into a community of individuals, more or less susceptible to the disease in question. The disease spreads from

What is the *size* of an epidemic?

- ▶ If we are interested in the possibility that an epidemic occurs
 - ▶ Does an epidemic peak always take place?
 - ▶ If it does take place, what is its size?

- ▶ If an epidemic traverses a population, is everyone affected/infected?

Kermack-McKendrick-type epidemic models

The Kermack-McKendrick (KMK) model

Mathematical analysis of KMK

The final size of a KMK epidemic

Herd immunity in KMK

The SLIAR model

Computing the final size more efficiently

A variation on the SLIAR model

A model with vaccination

Antiviral resistance

A COVID-19 model

In this case the equations are

$$\frac{dx}{dt} = -\kappa xy$$

$$\frac{dy}{dt} = \kappa xy - ly$$

$$\frac{dz}{dt} = ly$$

and as before $x + y + z = N$.

The Kermack-McKendrick SIR model without demography

- ▶ The period of time under consideration is sufficiently short that demography can be neglected (we also say the model has *no vital dynamics*)
- ▶ Individuals are either *susceptible* to the disease or *infected* by (and *infectious* with) the disease
- ▶ After recovering or dying from the disease, individuals are *removed* from the infectious compartment (R)
- ▶ Incidence is of **mass action** type and takes the form βSI

The state variables

We formulate the model as a system of **differential equations**

Differential equations: unknowns are *functions* (instead of scalars, like in algebraic equations)

At time $t \geq 0$ (we typically assume time starts at $t = 0$, but could also consider $t \geq t_0 > 0$), the **state variables**, in the current model, are the numbers of individuals who are

- ▶ susceptible to the disease: $S(t)$
- ▶ infected and infectious with the disease: $I(t)$
- ▶ removed from the infectious compartment: $R(t)$

Often, we drop the dependence on t if it is not explicitly required and write S, I, R

Important – Incidence functions

Incidence is the rate at which new cases arise, the incidence function then describes how contacts lead to new infections

If there are S susceptible individuals and I infectious individuals in the population, we use a function of the form

$$f(S, I)$$

The function can also explicitly depend on the total population N , i.e., $f(S, I, N)$

We return to incidence functions in Lecture 06

For now, just know the most common incidence functions are

- ▶ **mass action incidence** $f(S, I, N) = \beta SI$
- ▶ **standard (or proportional) incidence** $f(S, I, N) = \beta SI/N$

The Kermack-McKendrick model

This model is typically called the **Kermack-McKendrick (KMK) SIR model**

$$\frac{d}{dt}S(t) = -\beta S(t)I(t)$$

$$\frac{d}{dt}I(t) = \beta S(t)I(t) - \gamma I(t)$$

$$\frac{d}{dt}R(t) = \gamma I(t)$$

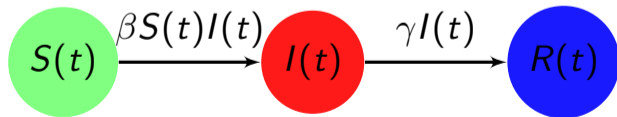

The Kermack-McKendrick model

As indicated, we often drop dependence on t of the state variables; we also write $X' := dX(t)/dt$. So the KMK model is usually written

$$S' = -\beta SI \quad (1a)$$

$$I' = \beta SI - \gamma I \quad (1b)$$

$$R' = \gamma I \quad (1c)$$

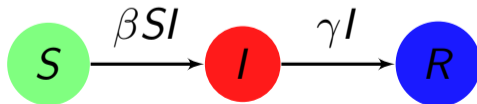

Kermack-McKendrick-type epidemic models

The Kermack-McKendrick (KMK) model

Mathematical analysis of KMK

The final size of a KMK epidemic

Herd immunity in KMK

The SLIAR model

Computing the final size more efficiently

A variation on the SLIAR model

A model with vaccination

Antiviral resistance

A COVID-19 model

Reduction of the model

3 compartments, but when considered in detail, we notice that *removed* do not have a direct influence on the dynamics of S or I , in the sense that R does not appear in (1a) or (1b)

Furthermore, the total population (including deceased who are also in R)

$N = S + I + R$ satisfies

$$N' = (S + I + R)' = 0$$

Thus, N is constant and

$$S(t) + I(t) + R(t) = N_0, \quad t \geq 0. \quad (2)$$

so the dynamics of R can be deduced from $R = N - (S + I)$. So we can consider

$$S' = -\beta SI \quad (3a)$$

$$I' = \beta SI - \gamma I \quad (3b)$$

Equilibria

Let us consider the equilibria of

$$S' = -\beta SI \tag{3a}$$

$$I' = (\beta S - \gamma)I \tag{3b}$$

From (3b)

- ▶ either $S^* = \gamma/\beta$
- ▶ or $I^* = 0$

Substitute into (3a)

- ▶ in the first case, $(S^*, I^*) = (\gamma/\beta, 0)$
- ▶ in the second case, any $S^* \geq 0$ is an EP

The second case is an *issue*: the usual linearisation does not work when there is a *continuum* of equilibria as the EP are not *isolated*

What is the problem with non-isolated EP?

Proposition 1

The Kermack-McKendrick model SIR model (1) has the continuum of equilibria

$$E_0^{KMK} := \{(S^*, I^*, R^*) = (S_\infty, 0, N_0 - S_\infty), \quad S_\infty \in [0, N_0]\} \quad (5)$$

Proof

Let us consider (1) and start with $I = I^* = 0$. Substitute this value into (1a) at equilibrium, giving $0 = -\gamma S^* I^* (= 0)$, meaning that any value of S^* satisfies this relation. From the conservation of the total population (2), the equilibrium E_0^{KMK} takes the form given by (5)

Now consider $S = S^* = \gamma/\beta$. Substituting this value into (1a) at equilibrium gives $0 = -\gamma I^*$, from which it follows that $I^* = 0$, and, using the conservation of total population (2),

$$(S^*, I^*, R^*) = \left(\frac{\gamma}{\beta}, 0, N_0 - \frac{\gamma}{\beta} \right) \quad (6)$$

is an equilibrium of (1). The equilibrium (6) is biologically relevant only when $N_0 - \gamma/\beta \geq 0$. Note that (5) includes (6) when the latter is biologically relevant

Adapting slightly the definitions in [Hirsch and Smale, 1974], consider the ordinary differential equation

$$x' = f(x) \tag{7}$$

where $x(t) \in W$ and $f : W \rightarrow E$ is a function such that solutions to (7) exist uniquely, e.g., a C^1 function, from an open set W of the vector space E into E

Denote $x(t, x_0)$ the solution to (7) through the initial value $x(t_0) = x_0$

A point $x^* \in W$ is an **equilibrium** if $f(x^*) = 0$

Definition 2 (Locally stable equilibrium)

An equilibrium point x^* of (7) is **locally stable** (LS) if for every neighbourhood $\mathcal{N}(x^*)$ of x^* in W , there is a neighbourhood $\mathcal{N}_1 \subseteq \mathcal{N}(x^*)$ of x^* such that every solution $x(t, x_0)$ with $x_0 \in \mathcal{N}_1$ is defined and in $\mathcal{N}(x^*)$ for all $t > t_0$

Definition 3 (Locally asymptotically stable equilibrium)

If \mathcal{N}_1 can be chosen so that in addition to the properties in Definition 2, $\lim_{t \rightarrow \infty} x(t, x_0) = x^*$ for all $x_0 \in \mathcal{N}_1$, then x^* is **locally asymptotically stable** (LAS)

DFE (5) of (1) are not **isolated**: any (open) neighbourhood of an equilibrium contains infinitely many other equilibria

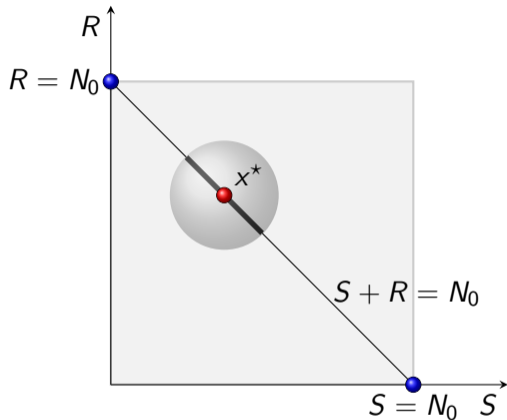

Neighbourhood $\mathcal{N}(x^*)$ of $x^* \in E_0^{\text{KMK}}$ lying on the $S - R$ plane (the neighbourhood extends above and below the $S - R$ plane in the I direction, not shown here). The thin line is E_0^{KMK} , the thick line is $E_0^{\text{KMK}} \cap \mathcal{N}(x^*)$

Proposition 4

Consider a disease-free equilibrium $x^ \in E_0^{KMK}$ of (1). Then x^* is LS but not LAS*

This means in particular that considering the Jacobian of (1) at the DFE **makes no sense!**

Proof

Let $x_1^* \in E_0^{\text{KMCK}}$ be an equilibrium of (1). Consider $\mathcal{S}_{\mathcal{N}}(x_1^*) \subset E_0^{\text{KMCK}}$, open subset of E_0^{KMCK} containing x_1^* . Now take some $x_2^* \in \mathcal{S}_{\mathcal{N}}(x_1^*)$. Since $x_2^* \in \mathcal{S}_{\mathcal{N}}(x_1^*) \subset E_0^{\text{KMCK}}$, x_2^* is an equilibrium of (1) and thus $x(t, x_2^*) = x_2^* \in \mathcal{S}_{\mathcal{N}}(x_1^*)$ for all $t \geq t_0$. As a consequence, x_1^* is locally stable

\Rightarrow any open neighbourhood $\mathcal{N}(x_1^*)$ contains $\mathcal{S}_{\mathcal{N}} = \mathcal{N}(x_1^*) \cap E_0^{\text{KMCK}}$

Consider, then, some $x_2^* \in \mathcal{S}_{\mathcal{N}}$. Since $x_2^* \in \mathcal{S}_{\mathcal{N}}$, x_2^* is an equilibrium and as a consequence, $\lim_{t \rightarrow \infty} x(t, x_2^*) = x_2^*$. Therefore, any open neighbourhood of x_1^* contains points x_0 not such that $\lim_{t \rightarrow \infty} x(t, x_0) = x_1^* \implies x_1^*$ is LS but not LAS

The next generation matrix method in this context

Consider the method in [van den Driessche and Watmough, 2002]

To construct \mathcal{R}_0 , they require *local stability*

Theorem 2 in [van den Driessche and Watmough, 2002] pertaining to LAS, on the other hand, has one assumption (assumption A5) that the DFE be *locally asymptotically stable*, with the assumption that all eigenvalues of the linearisation near a disease-free equilibrium have negative real parts

Clearly, this cannot be true with (1)

Another approach – Study dl/dS

$$S' = -\beta SI \quad (3a)$$

$$I' = \beta SI - \gamma I \quad (3b)$$

What is the dynamics of dl/dS ?

$$\frac{dl}{dS} = \frac{dl}{dt} \frac{dt}{dS} = \frac{I'}{S'} = \frac{\beta SI - \gamma I}{-\beta SI} = \frac{\gamma}{\beta S} - 1 \quad (8)$$

provided $S \neq 0$

Note – Recall that S and I are $S(t)$ and $I(t)$.. (8) thus describes the relation between S and I over solutions to the original ODE (3)

Integrate (8) and obtain trajectories in state space

$$I(S) = \frac{\gamma}{\beta} \ln S - S + C$$

with $C \in \mathbb{R}$

IC $I(S_0) = I_0 \Rightarrow C = S_0 + I_0 - \frac{\gamma}{\beta} \ln S_0$ and the solution to (1) is, as a function of S

$$I(S) = S_0 + I_0 - S + \frac{\gamma}{\beta} \ln \frac{S}{S_0}$$

$$R(S) = N - S - I(S) = R_0 - \frac{\gamma}{\beta} \ln \frac{S}{S_0}$$

(since $N_0 = S_0 + I_0 + R_0$)

Trajectories of (3) in (S, I) -space, normalised, with IC $(S_0, 1 - S_0)$ and $\beta/\gamma = 2.5$

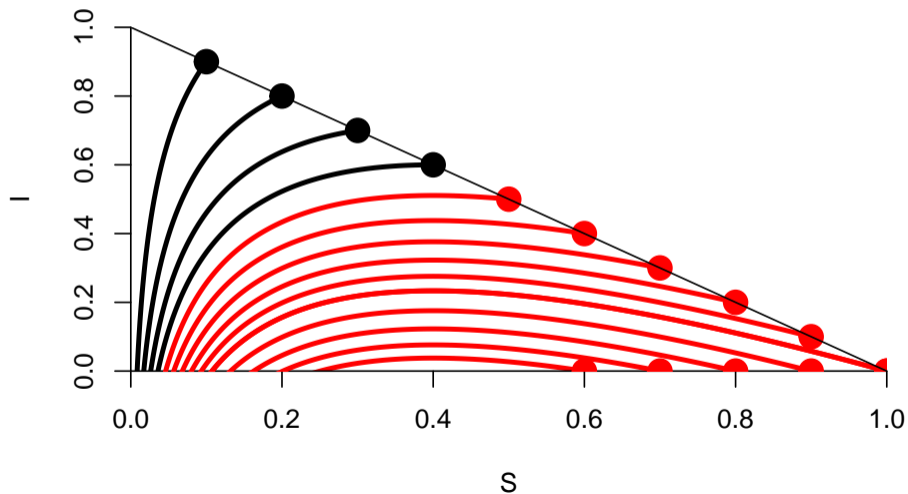

Let us study

$$I(S) = S_0 + I_0 - S + \frac{\gamma}{\beta} \ln \frac{S}{S_0}$$

We have

$$\frac{d}{dS} I(S) = \frac{\gamma}{\beta S} - 1$$

So, in the previous curves, the max of $I(S)$ happens when $S = \gamma/\beta$ ($S = 0.4$ in the example)

At that point,

$$I(S) = I_0 + \left(1 - \frac{1}{\mathcal{R}_0} - \frac{\ln(\mathcal{R}_0)}{\mathcal{R}_0} \right) S_0$$

Theorem 5 (Epidemic or no epidemic?)

Let $(S(t), I(t))$ be a solution to (3) and \mathcal{R}_0 defined by

$$\mathcal{R}_0 = \frac{\beta}{\gamma} S_0 \quad (9)$$

- ▶ If $\mathcal{R}_0 \leq 1$, then $I(t) \searrow 0$ when $t \rightarrow \infty$
- ▶ If $\mathcal{R}_0 > 1$, then $I(t)$ first reaches a maximum

$$I_0 + \left(1 - \frac{1}{\mathcal{R}_0} - \frac{\ln(\mathcal{R}_0)}{\mathcal{R}_0}\right) S_0 \quad (10)$$

then goes to 0 as $t \rightarrow \infty$

```

rhs_SIR_KMK <- function(t, x, p) {
  with(as.list(c(x, p)), {
    dS = - beta * S * I
    dI = beta * S * I - gamma * I
    dR = gamma * I
    return(list(c(dS, dI, dR)))
  })
}

# Initial condition for S (to compute R_0)
S0 = 1000
gamma = 1/14
# Set beta so that R_0 = 1.5
beta = 1.5 * gamma / S0
params = list(gamma = gamma, beta = beta)
IC = c(S = S0, I = 1, R = 0)
times = seq(0, 365, 1)
sol_KMK <- ode(IC, times, rhs_SIR_KMK, params)

```

```
plot(sol_KMK[, "time"], sol_KMK[, "I"],  
     type = "l", lwd = 2,  
     main = TeX("Kermack-McKendrick SIR,  $R_0=1.5$ "),  
     xlab = "Time (days)", ylab = "Prevalence")
```

Kermack–McKendrick SIR, $R_0 = 1.5$

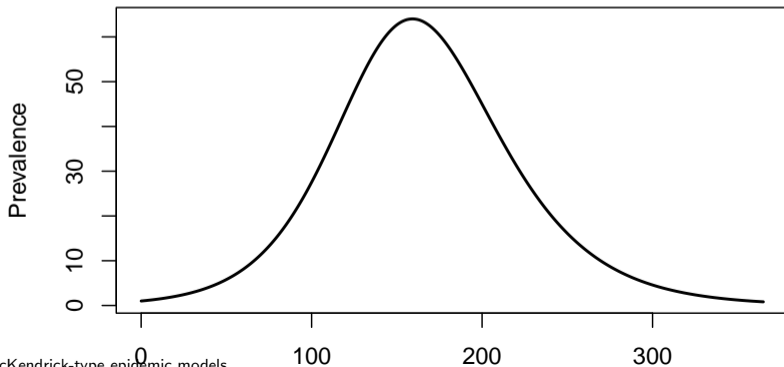

The basic reproduction number \mathcal{R}_0

- ▶ Indicator often used in epidemiology. Verbally
average number of secondary cases of infection produced when a single infectious individual is introduced in a wholly susceptible population
- ▶ If $\mathcal{R}_0 < 1$, then each infectious individual infects on average less than 1 person and the epidemic is quite likely to go extinct
- ▶ If $\mathcal{R}_0 > 1$, then each infectious individual infects on average more than 1 person and an epidemic is quite likely to occur

A few sample values of \mathcal{R}_0

\mathcal{R}_0 can be estimated from data (from the Anderson & May book)

Infection	Location	Period	\mathcal{R}_0
Measles	Cirencester, England	1947-50	13-14
	England and Wales	1950-68	16-18
	Kansas, USA	1918-21	5-6
	Ontario, Canada	1912-3	11-12
	Willesden, England	1912-3	11-12
	Ghana	1960-8	14-15
	East Nigeria	1960-8	16-17

Kermack-McKendrick-type epidemic models

The Kermack-McKendrick (KMK) model

Mathematical analysis of KMK

The final size of a KMK epidemic

Herd immunity in KMK

The SLIAR model

Computing the final size more efficiently

A variation on the SLIAR model

A model with vaccination

Antiviral resistance

A COVID-19 model

Final size of an epidemic

For a nonnegative valued integrable function $w(t)$, denote

$$w_0 = w(0), \quad w_\infty = \lim_{t \rightarrow \infty} w(t), \quad \hat{w} = \int_0^\infty w(t) dt$$

In the subsystem

$$S' = -\beta SI \tag{3a}$$

$$I' = \beta SI - \gamma I \tag{3b}$$

compute the sum of (3a) and (3b), making sure to show time dependence

$$\frac{d}{dt}(S(t) + I(t)) = -\gamma I(t)$$

Integrate from 0 to ∞ :

$$\int_0^{\infty} \frac{d}{dt}(S(t) + I(t)) dt = - \int_0^{\infty} \gamma I(t) dt$$

The left hand side gives

$$\int_0^{\infty} \frac{d}{dt}(S(t) + I(t)) dt = S_{\infty} + I_{\infty} - S_0 - I_0 = S_{\infty} - S_0 - I_0$$

since $I_{\infty} = 0$

The right hand side takes the form

$$- \int_0^{\infty} \gamma I(t) dt = -\gamma \int_0^{\infty} I(t) dt = -\gamma \hat{I}$$

We thus have

$$S_{\infty} - S_0 - I_0 = -\gamma \hat{I} \tag{11}$$

Now consider (3a):

$$S' = -\beta SI$$

Divide both sides by S :

$$\frac{S'(t)}{S(t)} = -\beta I(t)$$

Integrate from 0 to ∞ :

$$\ln S_\infty - \ln S_0 = -\beta \hat{I} \tag{12}$$

Express (11) and (12) in terms of $-\hat{I}$ and equate

$$\frac{\ln S_\infty - \ln S_0}{\beta} = \frac{S_\infty - S_0 - I_0}{\gamma}$$

Thus we have

$$(\ln S_0 - \ln S_\infty)S_0 = (S_0 - S_\infty)\mathcal{R}_0 + I_0\mathcal{R}_0 \tag{13}$$

Theorem 6 (Final size relation)

Let $(S(t), I(t))$ be a solution to (3) and \mathcal{R}_0 defined by (9)

The number $S(t)$ of susceptible individuals is a nonincreasing function and its limit S_∞ is the only solution in $(0, S_0)$ of the transcendental equation

$$(\ln S_0 - \ln S_\infty)S_0 = (S_0 - S_\infty)\mathcal{R}_0 + I_0\mathcal{R}_0 \quad (13)$$

The (transcendental) final size equation

Rewrite the final size equation

$$(\ln S_0 - \ln S_\infty)S_0 = (S_0 - S_\infty)\mathcal{R}_0 + I_0\mathcal{R}_0 \quad (13)$$

as

$$T(S_\infty) = (\ln S_0 - \ln S_\infty)S_0 - (S_0 - S_\infty)\mathcal{R}_0 - I_0\mathcal{R}_0 \quad (14)$$

Thus, we seek the zeros of the function $T(S_\infty)$

We seek S_∞ in $(0, S_0]$ s.t. $T(S_\infty) = 0$, with

$$T(S_\infty) = (\ln S_0 - \ln S_\infty)S_0 - (S_0 - S_\infty)\mathcal{R}_0 - I_0\mathcal{R}_0 \quad (14)$$

Note to begin that

$$\lim_{S_\infty \rightarrow 0} T(S_\infty) = \lim_{S_\infty \rightarrow 0} -S_0 \ln(S_\infty) = \infty$$

Differentiating T with respect to S_∞ , we get

$$T'(S_\infty) = \mathcal{R}_0 - S_0/S_\infty$$

When $S_\infty \rightarrow 0$, $\mathcal{R}_0 - S_0/S_\infty < 0$, so T decreases to $S_\infty = S_0/\mathcal{R}_0$

So if $\mathcal{R}_0 \leq 1$, the function T is decreasing on $(0, S_0)$, while it has a minimum if $\mathcal{R}_0 > 1$

Case $\mathcal{R}_0 \leq 1$

$$T(S_\infty) = (\ln S_0 - \ln S_\infty)S_0 - (S_0 - S_\infty)\mathcal{R}_0 - I_0\mathcal{R}_0 \quad (14)$$

- ▶ We have seen that T decreases on $(0, S_0]$
 - ▶ Also, $T(S_0) = -I_0\mathcal{R}_0 < 0$ ($I_0 = 0$ is trivial and not considered)
 - ▶ T is continuous
- \implies there exists a unique $S_\infty \in (0, S_0]$ s.t. $T(S_\infty) = 0$

Case $\mathcal{R}_0 > 1$

$$T(S_\infty) = (\ln S_0 - \ln S_\infty)S_0 - (S_0 - S_\infty)\mathcal{R}_0 - I_0\mathcal{R}_0 \quad (14)$$

► We have seen that T decreases on $(0, S_0/\mathcal{R}_0]$

► For $S_\infty \in [S_0/\mathcal{R}_0]$, $T' > 0$

► As before, $T(S_\infty) = -I_0\mathcal{R}_0$

► T is continuous

\implies there exists a unique $S_\infty \in (0, S_0]$ s.t. $T(S_\infty) = 0$. More precisely, in this case, $S_\infty \in (0, S_0/\mathcal{R}_0)$

We solve numerically. We need a function

```
final_size_eq = function(S_inf, S0 = 999, I0 = 1, R_0 = 2.5) {  
  OUT = S0*(log(S0)-log(S_inf)) - (S0+I0-S_inf)*R_0  
  return(OUT)  
}
```

and solve easily using uniroot:

```
uniroot(f = final_size_eq, interval = c(0.05, 999))  
  
## $root  
## [1] 106.8819  
##  
## $f.root  
## [1] -2.649285e-07  
##  
## $iter  
## [1] 10  
##
```

A function to use this..

```
final_size = function(L) {  
  with(as.list(L), {  
    S_inf = uniroot(f = function(x)  
      final_size_eq(S_inf = x,  
                    S0 = S0, I0 = I0,  
                    R_0 = R_0),  
                  interval = c(0.05, S0))  
    return(S_inf$root)  
  })  
}
```

A figure with all the information

```
NO = 1000
IO = 1
SO = NO-IO
R_0 = 0.8
S = seq(0.1, SO, by = 0.1)
fs = final_size_eq(S, SO = SO, IO = IO, R_0 = R_0)
S_inf = uniroot(f = function(x) final_size_eq(S_inf = x,
                                                SO = SO, IO = IO,
                                                R_0 = R_0),
               interval = c(0.05, SO))
plot(S, fs, type = "l", ylab = "Value of equation (10)")
abline(h = 0)
points(x = S_inf$root, y = 0, pch = 19)
text(x = S_inf$root, y = 0, labels = "S_inf", adj = c(-0.25,-1))
```

$$\mathcal{R}_0 = 0.8$$

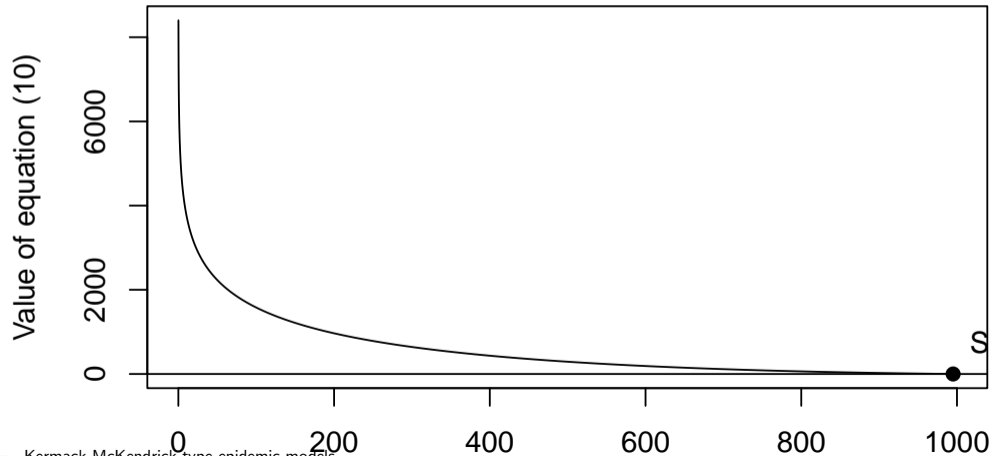

$$\mathcal{R}_0 = 2.4$$

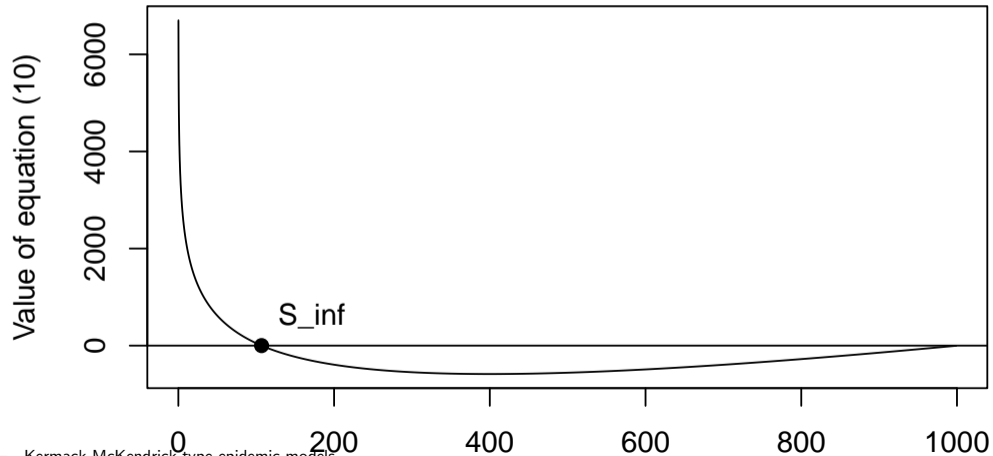

A little nicer

```
values = expand.grid(
  R_0 = seq(0.01, 3, by = 0.01),
  I0 = seq(1, 100, 1)
)
values$S0 = N0-values$I0
L = split(values, 1:nrow(values))
values$S_inf = sapply(X = L, FUN = final_size)
values$final_size = values$S0-values$S_inf+values$I0
values$attack_rate = (values$final_size / N0)*100

p = levelplot(attack_rate ~ R_0*I0, data = values,
  xlab = TeX("$R_0$"), ylab = "I(0)",
  col.regions = viridis(100))

print(p)
```

(requires lattice, viridis and latex2exp libraries)

Attack rate (in %)

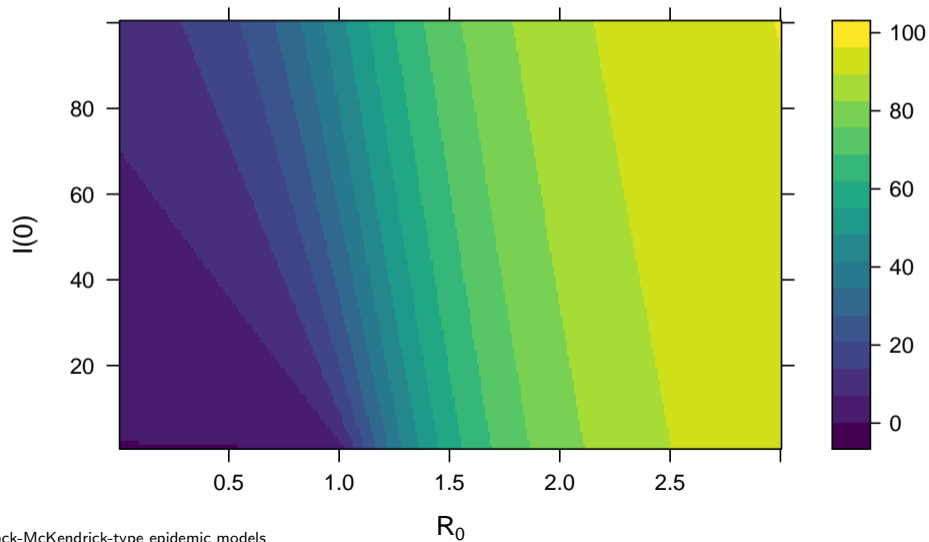

Kermack-McKendrick-type epidemic models

The Kermack-McKendrick (KMK) model

Mathematical analysis of KMK

The final size of a KMK epidemic

Herd immunity in KMK

The SLIAR model

Computing the final size more efficiently

A variation on the SLIAR model

A model with vaccination

Antiviral resistance

A COVID-19 model

The simplest vaccination model

To implement vaccination in KMK, assume that vaccination reduces the number of susceptibles

Let total population be N with S_0 initially susceptible

Vaccinate a fraction $p \in [0, 1]$ of susceptible individuals

Original IC (for simplicity, $R(0) = 0$)

$$IC : (S(0), I(0), R(0)) = (S_0, I_0, 0) \quad (15)$$

Post-vaccination IC

$$IC : (S(0), I(0), R(0)) = ((1 - p)S_0, I_0, pS_0) \quad (16)$$

Vaccination reproduction number

Without vaccination

$$\mathcal{R}_0 = \frac{\beta}{\gamma} S_0 \quad (9)$$

With vaccination, denoting \mathcal{R}_v the reproduction number,

$$\mathcal{R}_v = \frac{\beta}{\gamma} (1 - p) S_0 \quad (17)$$

Since $p \in [0, 1]$, $\mathcal{R}_v \leq \mathcal{R}_0$

Herd immunity

Therefore

- ▶ $\mathcal{R}_v < \mathcal{R}_0$ if $p > 0$
- ▶ To control the disease, \mathcal{R}_v must take a value less than 1

To make \mathcal{R}_v less than 1

$$\mathcal{R}_v < 1 \iff p > 1 - \frac{1}{\mathcal{R}_0} \quad (18)$$

By vaccinating a fraction $p > 1 - 1/\mathcal{R}_0$ of the susceptible population, we thus are in a situation where an epidemic peak is precluded (or, at the very least, the final size is reduced)

This is **herd immunity**

Kermack-McKendrick-type epidemic models

The Kermack-McKendrick (KMK) model

Mathematical analysis of KMK

The final size of a KMK epidemic

Herd immunity in KMK

The SLIAR model

Computing the final size more efficiently

A variation on the SLIAR model

A model with vaccination

Antiviral resistance

A COVID-19 model

Simple models for containment of a pandemic

Julien Arino^{1,*}, Fred Brauer², P. van den Driessche³, James Watmough⁴
and Jianhong Wu⁵

¹*Department of Mathematics, University of Manitoba, Winnipeg,
Manitoba R3T 2N2, Canada*

²*Department of Mathematics, University of British Columbia,
Vancouver, British Columbia V6T 1Z2, Canada*

³*Department of Mathematics and Statistics, University of Victoria,
Victoria, British Columbia V8W 3P4, Canada*

⁴*Department of Mathematics and Statistics, University of New Brunswick,
Fredericton, New Brunswick E3B 5A3, Canada*

⁵*Department of Mathematics and Statistics, York University,
Toronto, Ontario M3J 1P3, Canada*

SIR is a little too simple for many diseases:

- ▶ No incubation period
- ▶ A lot of infectious diseases (in particular respiratory) have mild and less mild forms depending on the patient

⇒ model with SIR but also L(atent) and (A)symptomatic individuals, in which I are now symptomatic individuals

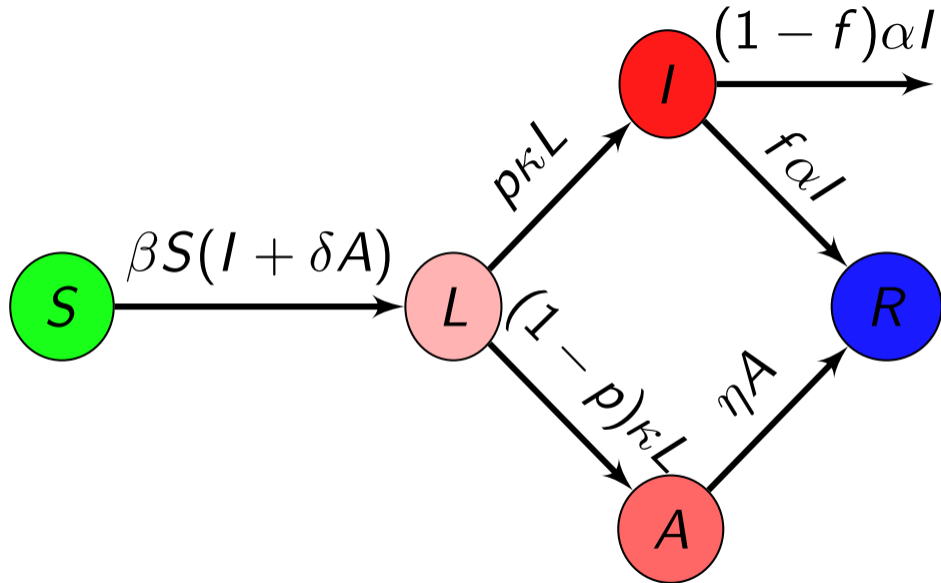

Basic reproduction number & Final size

We find the basic reproduction number

$$\mathcal{R}_0 = \beta \left(\frac{\rho}{\alpha} + \frac{\delta(1-\rho)}{\eta} \right) S_0 = \frac{\beta\rho}{\alpha} S_0 \quad (19)$$

where

$$\rho = \alpha \left(\frac{\rho}{\alpha} + \frac{\delta(1-\rho)}{\eta} \right)$$

The final size relation takes the form

$$S_0(\ln S_0 - \ln S_\infty) = \mathcal{R}_0(S_0 - S_\infty) + \frac{\mathcal{R}_0 I_0}{\rho} \quad (20)$$

Adding treatment

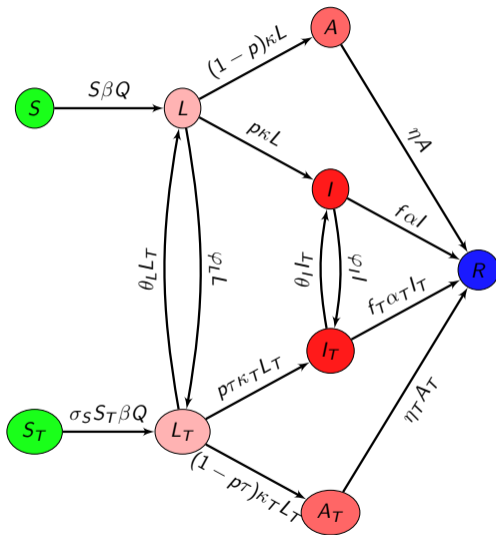

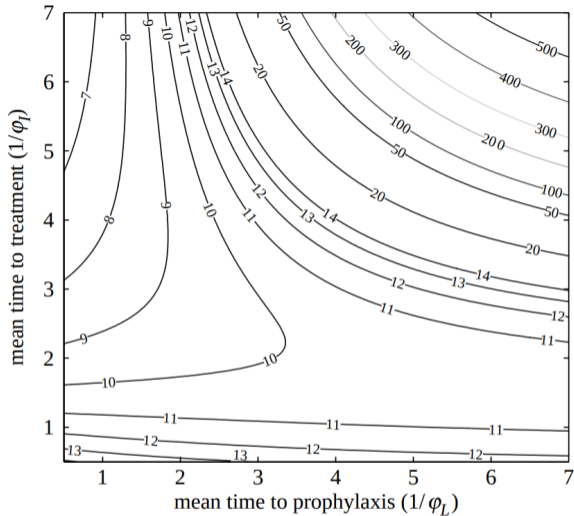

Figure 3. Total number of doses used in a population of 1000 individuals over the course of the outbreak as a function of the mean times to treatment and prophylaxis (in days), for $\mathcal{R}_0 = 1.5$, with $S_0 = 999$ and $I_0 = 1$.

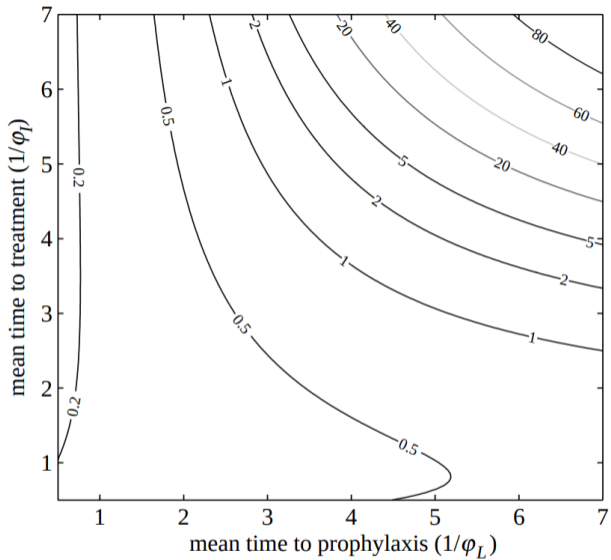

Figure 4. Total cases as a function of the treatment rates, for $\mathcal{R}_0=1.5$, with $S_0=999$ and $I_0=1$.

5. CONCLUSIONS

Compartmental models facilitate the analysis of sensitivity of the model to errors in measuring parameters or to changes in the control parameters. This is particularly valuable before the beginning of an epidemic when the values of some parameters are only guesses. For example, a sensitivity analysis of our model shows the importance of estimating the parameter p representing the fraction of latent members that will develop symptoms. This parameter is almost impossible to determine accurately, and it is taken to be $2/3$ in Longini *et al.* (2004) and $1/2$ in Ferguson *et al.* (2005). In view of the many uncertainties in estimating parameters for pandemic influenza, it is important to consider a large range of values, and the simplicity of calculation offered by a deterministic compartmental model lends itself to doing this as an initial step before more complicated models such as those of Ferguson *et al.* (2005) and Longini *et al.* (2005) are invoked. The calculations reported here involve nothing more complicated than the solution of a system of two transcendental equations.

In Memoriam - Fred Brauer

Fred Brauer was a friend and mentor to many worldwide and an *éminence grise* of Mathematical Epidemiology in Canada

I was privileged to learn from him and teach math epi with him all over the place

Fred passed away 2021-10-17. He would have loved to teach you about about math epi and share pearls of wisdom from the *Eminent Modern Philosopher Yogi Berra!*

When you learn to use a hammer,
everything looks like a nail [A. Maslow]



Kermack-McKendrick-type epidemic models

The Kermack-McKendrick (KMK) model

Mathematical analysis of KMK

The final size of a KMK epidemic

Herd immunity in KMK

The SLIAR model

Computing the final size more efficiently

A variation on the SLIAR model

A model with vaccination

Antiviral resistance

A COVID-19 model

A FINAL SIZE RELATION FOR EPIDEMIC MODELS

JULIEN ARINO

Department of Mathematics, University of Manitoba
Winnipeg, Manitoba R3T 2N2, Canada

FRED BRAUER

Department of Mathematics, University of British Columbia
Vancouver, BC V6T 1Z2, Canada

P. VAN DEN DRIESSCHE

Department of Mathematics and Statistics, University of Victoria
Victoria, B.C. V8W 3P4, Canada

JAMES WATMOUGH

Department of Mathematics and Statistics, University of New Brunswick
Fredericton, N.B. E3B 5A3, Canada

JIANHONG WU

Department of Mathematics and Statistics, York University
Toronto, Ontario M3J 1P3, Canada

(Communicated by Zhilan Feng)

A method for computing \mathcal{R}_0 in epidemic models

- ▶ This method is not universal! It works in a relatively large class of models, but not everywhere
- ▶ If it doesn't work, the next generation matrix method does work, **but** should be considered only for obtaining the reproduction number, not to deduce LAS
- ▶ Here, I change the notation in the paper, for convenience

Standard form of the system

Suppose system can be written in the form

$$\mathbf{S}' = \mathbf{b}(\mathbf{S}, \mathbf{I}, \mathbf{R}) - \mathbf{D}\mathbf{S}\beta(\mathbf{S}, \mathbf{I}, \mathbf{R})h\mathbf{I} \quad (21a)$$

$$\mathbf{I}' = \mathbf{\Pi}\mathbf{D}\mathbf{S}\beta(\mathbf{S}, \mathbf{I}, \mathbf{R})h\mathbf{I} - \mathbf{V}\mathbf{I} \quad (21b)$$

$$\mathbf{R}' = \mathbf{f}(\mathbf{S}, \mathbf{I}, \mathbf{R}) + \mathbf{W}\mathbf{I} \quad (21c)$$

where $\mathbf{S} \in \mathbb{R}^m$, $\mathbf{I} \in \mathbb{R}^n$ and $\mathbf{R} \in \mathbb{R}^k$ are susceptible, infected and removed compartments, respectively

IC are ≥ 0 with at least one of the components of $\mathbf{I}(0)$ positive

$$\mathbf{S}' = \mathbf{b}(\mathbf{S}, \mathbf{I}, \mathbf{R}) - \mathbf{D}\mathbf{S}\beta(\mathbf{S}, \mathbf{I}, \mathbf{R})\mathbf{h} \quad (21a)$$

- ▶ $\mathbf{b} : \mathbb{R}_+^m \times \mathbb{R}_+^n \times \mathbb{R}_+^k \rightarrow \mathbb{R}^m$ continuous function encoding recruitment and death of uninfected individuals
- ▶ $\mathbf{D} \in \mathbb{R}^{m \times m}$ diagonal with diagonal entries $\sigma_i > 0$ the relative susceptibilities of susceptible compartments, with convention that $\sigma_1 = 1$
- ▶ Scalar valued function $\beta : \mathbb{R}_+^m \times \mathbb{R}_+^n \times \mathbb{R}_+^k \rightarrow \mathbb{R}_+$ represents infectivity, with, e.g., $\beta(\mathbf{S}, \mathbf{I}, \mathbf{R}) = \beta$ for mass action
- ▶ $\mathbf{h} \in \mathbb{R}^n$ row vector of relative horizontal transmissions

$$I' = \mathbf{\Pi D S} \beta(\mathbf{S}, \mathbf{I}, \mathbf{R}) \mathbf{h} \mathbf{I} - \mathbf{V} \mathbf{I} \quad (21b)$$

- ▶ $\mathbf{\Pi} \in \mathbb{R}^{n \times m}$ has (i, j) entry the fraction of individuals in j^{th} susceptible compartment that enter i^{th} infected compartment upon infection
- ▶ $\mathbf{D} \in \mathbb{R}^{m \times m}$ diagonal with diagonal entries $\sigma_i > 0$ the relative susceptibilities of susceptible compartments, with convention that $\sigma_1 = 1$
- ▶ Scalar valued function $\beta : \mathbb{R}_+^m \times \mathbb{R}_+^n \times \mathbb{R}_+^k \rightarrow \mathbb{R}_+$ represents infectivity, with, e.g., $\beta(\mathbf{S}, \mathbf{I}, \mathbf{R}) = \beta$ for mass action
- ▶ $\mathbf{h} \in \mathbb{R}^n$ row vector of relative horizontal transmissions
- ▶ $\mathbf{V} \in \mathbb{R}^{n \times n}$ describes transitions between infected states and removals from these states due to recovery or death

$$R' = f(S, I, R) + WI \quad (21c)$$

- ▶ $f : \mathbb{R}_+^m \times \mathbb{R}_+^n \times \mathbb{R}_+^k \rightarrow \mathbb{R}^k$ continuous function encoding flows into and out of removed compartments because of immunisation or similar processes
- ▶ $W \in \mathbb{R}^{k \times n}$ has (i, j) entry the rate at which individuals in the j^{th} infected compartment move into the i^{th} removed compartment

Suppose \mathbf{E}_0 is a locally stable disease-free equilibrium (DFE) of the system without disease, i.e., an EP of

$$\mathbf{S}' = \mathbf{b}(\mathbf{S}, \mathbf{0}, R)$$

$$R' = f(\mathbf{S}, \mathbf{0}, R)$$

Theorem 7

Let

$$\mathcal{R}_0 = \beta(\mathbf{S}_0, \mathbf{0}, R_0) \mathbf{h} \mathbf{V}^{-1} \mathbf{\Pi} \mathbf{D} \mathbf{S}_0 \quad (22)$$

- ▶ If $\mathcal{R}_0 < 1$, the DFE \mathbf{E}_0 is a locally asymptotically stable EP of (21)
- ▶ If $\mathcal{R}_0 > 1$, the DFE \mathbf{E}_0 of (21) is unstable

If no demography (epidemic model), then just \mathcal{R}_0 , of course

Final size relations

Assume no demography, then system should be writeable as

$$\mathbf{S}' = -\mathbf{D}\mathbf{S}\beta(\mathbf{S}, \mathbf{I}, \mathbf{R})h\mathbf{I} \quad (23a)$$

$$\mathbf{I}' = \mathbf{\Pi}\mathbf{D}\mathbf{S}\beta(\mathbf{S}, \mathbf{I}, \mathbf{R})h\mathbf{I} - \mathbf{V}\mathbf{I} \quad (23b)$$

$$\mathbf{R}' = \mathbf{W}\mathbf{I} \quad (23c)$$

For $w(t) \in \mathbb{R}_+^n$ continuous, define

$$w_\infty = \lim_{t \rightarrow \infty} w(t) \quad \text{and} \quad \hat{w} = \int_0^\infty w(t) dt$$

Define the row vector

$$\mathbb{R}^m \ni \mathbf{\Gamma} = (\Gamma_1, \dots, \Gamma_m) = \beta(\mathbf{S}_0, \mathbf{0}, \mathbf{R}_0) \mathbf{hV}^{-1} \mathbf{\Pi D}$$

then

$$\mathcal{R}_0 = \mathbf{\Gamma S}(0)$$

Suppose incidence is mass action, i.e., $\beta(\mathbf{S}, \mathbf{I}, \mathbf{R}) = \beta$ and $m > 1$

Then for $i = 1, \dots, m$, express $\mathbf{S}_i(\infty)$ as a function of $\mathbf{S}_1(\infty)$ using

$$\mathbf{S}_i(\infty) = \mathbf{S}_i(0) \left(\frac{\mathbf{S}_1(\infty)}{\mathbf{S}_1(0)} \right)^{\sigma_i/\sigma_1}$$

then substitute into

$$\begin{aligned} \frac{1}{\sigma_i} \ln \left(\frac{\mathbf{S}_i(0)}{\mathbf{S}_i(\infty)} \right) &= \mathbf{\Gamma D}^{-1} (\mathbf{S}(0) - \mathbf{S}(\infty)) + \beta \mathbf{hV}^{-1} \mathbf{I}(0) \\ &= \frac{1}{\sigma_1} \ln \left(\frac{\mathbf{S}_1(0)}{\mathbf{S}_1(\infty)} \right) \end{aligned}$$

which is a final size relation for the general system when $\mathbf{S}_i(0) > 0$

If incidence is mass action and $m = 1$ (only one susceptible compartment), reduces to the KMK form

$$\ln \left(\frac{S_0}{S_\infty} \right) = \frac{\mathcal{R}_0}{S_0} (S_0 - S_\infty) + \beta \mathbf{hV}^{-1} \mathbf{I}_0 \quad (24)$$

In the case of more general incidence functions, the final size relations are inequalities of the form, for $i = 1, \dots, m$,

$$\ln \left(\frac{\mathbf{S}_i(0)}{\mathbf{S}_i(\infty)} \right) \geq \sigma_i \mathbf{\Gamma} \mathbf{D}^{-1} (\mathbf{S}(0) - \mathbf{S}(\infty)) + \sigma_i \beta(K) \mathbf{h} \mathbf{V}^{-1} \mathbf{I}(0)$$

where K is the initial total population

Kermack-McKendrick-type epidemic models

The Kermack-McKendrick (KMK) model

Mathematical analysis of KMK

The final size of a KMK epidemic

Herd immunity in KMK

The SLIAR model

Computing the final size more efficiently

A variation on the SLIAR model

A model with vaccination

Antiviral resistance

A COVID-19 model

The SLIAR model

- ▶ Paper we have already seen: Arino, Brauer, PvdD, Watmough & Wu. Simple models for containment of a pandemic, *Journal of the Royal Society Interface* (2006)

- ▶ However, suppose additionally that L are also infectious

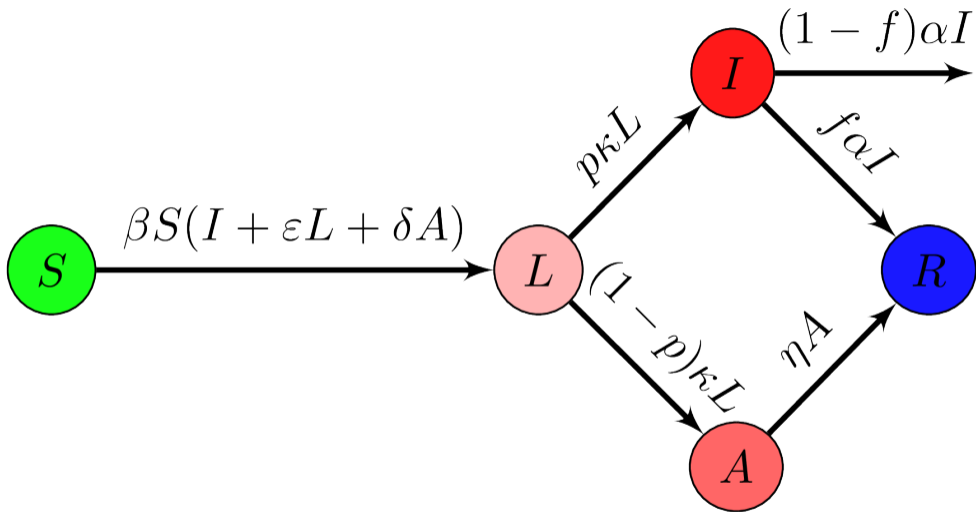

Here, $\mathbf{S} = S$, $\mathbf{I} = (L, I, A)^T$ and $\mathbf{R} = R$, so $m = 1$, $n = 3$ and

$$\mathbf{h} = [\varepsilon \ 1 \ \delta], \quad \mathbf{D} = 1, \quad \mathbf{\Pi} = \begin{pmatrix} 1 \\ 0 \\ 0 \end{pmatrix} \quad \text{and} \quad \mathbf{V} = \begin{pmatrix} \kappa & 0 & 0 \\ -p\kappa & \alpha & 0 \\ -(1-p)\kappa & 0 & \eta \end{pmatrix}$$

Incidence is mass action so $\beta(\mathbf{E}_0) = \beta$ and thus

$$\begin{aligned} \mathcal{R}_0 &= \beta \mathbf{h} \mathbf{V}^{-1} \mathbf{\Pi} \mathbf{D} \mathbf{S}_0 \\ &= \beta [\varepsilon \ 1 \ \delta] \begin{pmatrix} 1/\kappa & 0 & 0 \\ p/\alpha & 1/\alpha & 0 \\ (1-p)/\eta & 0 & 1/\eta \end{pmatrix} \begin{pmatrix} 1 \\ 0 \\ 0 \end{pmatrix} S_0 \\ &= \beta S_0 \left(\frac{\varepsilon}{\kappa} + \frac{p}{\alpha} + \frac{\delta(1-p)}{\eta} \right) \end{aligned}$$

For final size, since $m = 1$, we can use (24):

$$\ln \left(\frac{S_0}{S_\infty} \right) = \frac{\mathcal{R}_0}{S_0} (S_0 - S_\infty) + \beta \mathbf{hV}^{-1} \mathbf{l}_0$$

Suppose $\mathbf{l}_0 = (0, l_0, 0)$, then

$$\ln \left(\frac{S_0}{S_\infty} \right) = \mathcal{R}_0 \frac{S_0 - S_\infty}{S_0} + \frac{\beta}{\alpha} l_0$$

If $\mathbf{l}_0 = (L_0, l_0, A_0)$, then

$$\ln \left(\frac{S_0}{S_\infty} \right) = \mathcal{R}_0 \frac{S_0 - S_\infty}{S_0} + \beta \left(\frac{\varepsilon}{\kappa} + \frac{\rho}{\alpha} + \frac{\delta(1-\rho)}{\eta} \right) L_0 + \frac{\beta\delta}{\eta} A_0 + \frac{\beta}{\alpha} l_0$$

Kermack-McKendrick-type epidemic models

The Kermack-McKendrick (KMK) model

Mathematical analysis of KMK

The final size of a KMK epidemic

Herd immunity in KMK

The SLIAR model

Computing the final size more efficiently

A variation on the SLIAR model

A model with vaccination

Antiviral resistance

A COVID-19 model

A model with vaccination

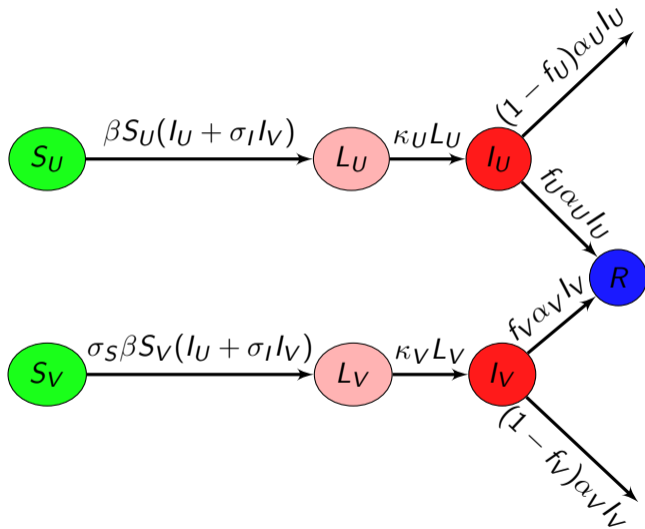

A model with vaccination

Fraction γ of S_0 are vaccinated before the epidemic; vaccination reduces probability and duration of infection, infectiousness and reduces mortality

$$S_U' = -\beta S_U [I_U + \sigma_I I_V] \quad (25a)$$

$$S_V' = -\sigma_S \beta S_V [I_U + \sigma_I I_V] \quad (25b)$$

$$L_U' = \beta S_U [I_U + \sigma_I I_V] - \kappa_U L_U \quad (25c)$$

$$L_V' = \sigma_S \beta S_V [I_U + \sigma_I I_V] - \kappa_V L_V \quad (25d)$$

$$I_U' = \kappa_U L_U - \alpha_U I_U \quad (25e)$$

$$I_V' = \kappa_V L_V - \alpha_V I_V \quad (25f)$$

$$R' = f_U \alpha_U I_U + f_V \alpha_V I_V \quad (25g)$$

with $S_U(0) = (1 - \gamma)S_0$ and $S_V(0) = \gamma S_0$

Here, $m = 2$, $n = 4$,

$$\mathbf{h} = [0 \ 0 \ 1 \ \sigma_I], \quad \mathbf{D} = \begin{pmatrix} 1 & 0 \\ 0 & \sigma_S \end{pmatrix}, \quad \mathbf{\Pi} = \begin{pmatrix} 1 & 0 \\ 0 & 1 \\ 0 & 0 \\ 0 & 0 \end{pmatrix}$$

and

$$\mathbf{V} = \begin{pmatrix} \kappa_U & 0 & 0 & 0 \\ 0 & \kappa_V & 0 & 0 \\ -\kappa_U & 0 & \alpha_U & 0 \\ 0 & -\kappa_V & 0 & \alpha_V \end{pmatrix}$$

So

$$\mathbf{\Gamma} = \begin{bmatrix} \frac{\beta}{\alpha_U} & \frac{\sigma_I \sigma_S \beta}{\alpha_V} \end{bmatrix}, \quad \mathcal{R}_c = S_0 \beta \left(\frac{1 - \gamma}{\alpha_U} + \frac{\sigma_I \sigma_S \gamma}{\alpha_V} \right)$$

and the final size relation is

$$\ln \left(\frac{(1 - \gamma) S_U(0)}{S_U(\infty)} \right) = \frac{\beta}{\alpha_U} [(1 - \gamma) S_U(0) - S_U(\infty)] + \frac{\sigma_I \beta}{\alpha_V} [\gamma S_V(0) - S_V(\infty)] + \frac{\beta}{\alpha_U} I_0$$

$$S_V(\infty) = \gamma S_U(0) \left(\frac{S_U(\infty)}{(1 - \gamma) S_0} \right)^{\sigma_S}$$

Kermack-McKendrick-type epidemic models

The Kermack-McKendrick (KMK) model

Mathematical analysis of KMK

The final size of a KMK epidemic

Herd immunity in KMK

The SLIAR model

Computing the final size more efficiently

A variation on the SLIAR model

A model with vaccination

Antiviral resistance

A COVID-19 model

Research article

Open Access

Antiviral resistance during pandemic influenza: implications for stockpiling and drug use

Julien Arino^{1,2}, Christopher S Bowman^{2,3} and Seyed M Moghadas^{*2,4,5}

Address: ¹Department of Mathematics, University of Manitoba, Winnipeg, Manitoba R3T 2N2, Canada , ²Institute for Biodiagnostics, National Research Council Canada, Winnipeg, Manitoba R3B 1Y6, Canada , ³Department of Electrical and Computer Engineering, University of Manitoba, Winnipeg, Manitoba R3T 5V6, Canada , ⁴Department of Mathematics and Statistics, University of Winnipeg, Winnipeg, Manitoba R3B 2E9, Canada and ⁵Department of Statistics, University of Manitoba, Winnipeg, Manitoba R3T 2N2, Canada

Email: Julien Arino - arinoj@cc.umanitoba.ca; Christopher S Bowman - chris.bowman@nrc-cnrc.gc.ca;
Seyed M Moghadas* - seyed.moghadas@nrc-cnrc.gc.ca

* Corresponding author

Published: 22 January 2009

BMC Infectious Diseases 2009, 9:8 doi:10.1186/1471-2334-9-8

Received: 5 August 2008

Accepted: 22 January 2009

Adapting treatment to counter emergence of resistance

This work was undertaken at the request of the Public Health Agency of Canada during the pandemic preparedness phase prior to the 2009 p-H1N1 pandemic

Problem: we have antivirals to use against influenza, either prophylactically or curatively. Using these antivirals may promote the emergence of antiviral-resistant strains. How do we minimise this risk?

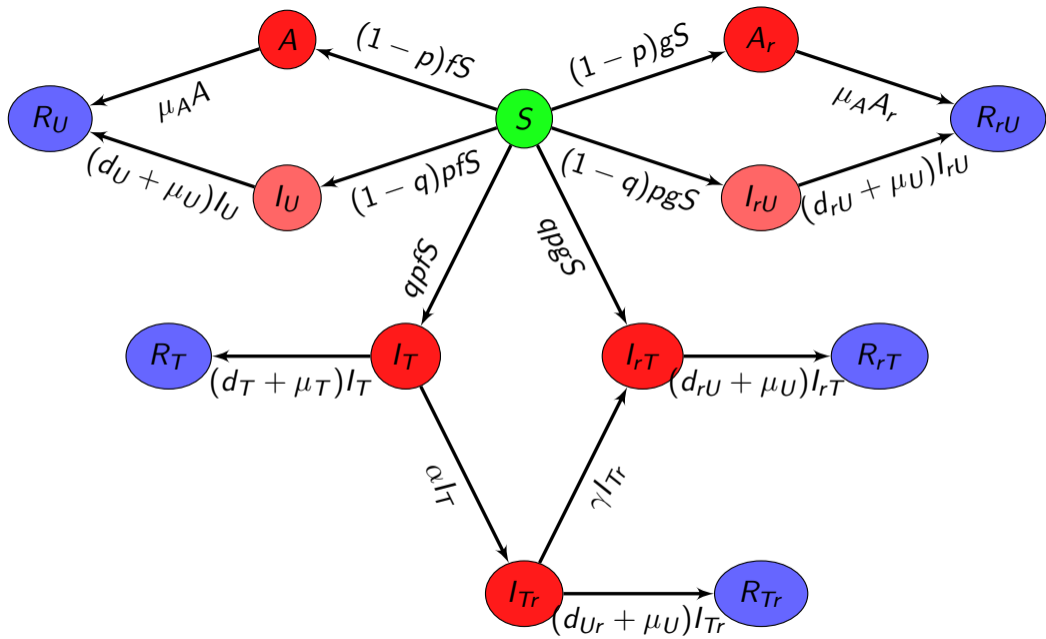

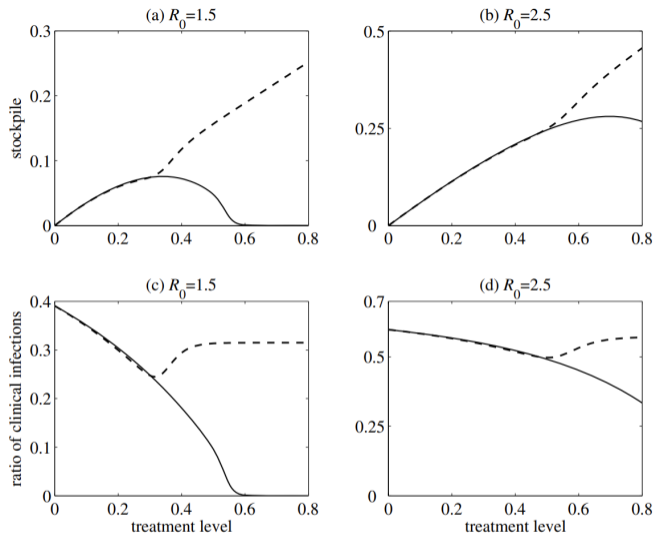

Figure 2

Required antiviral stockpile and ratio of the total clinical infections. Required stockpile of antiviral drugs (relative to S_0) as a function of the treatment level for (a) $R_0 = 1.5$; and (b) $R_0 = 2.5$. Ratio of the total number of clinical infections to S_0 as a function of the treatment level for: (c) $R_0 = 1.5$; and (d) $R_0 = 2.5$. Solid curves correspond to the case where resistance is absent, and dashed curves represent the scenario in which resistant viruses with HTF are present.

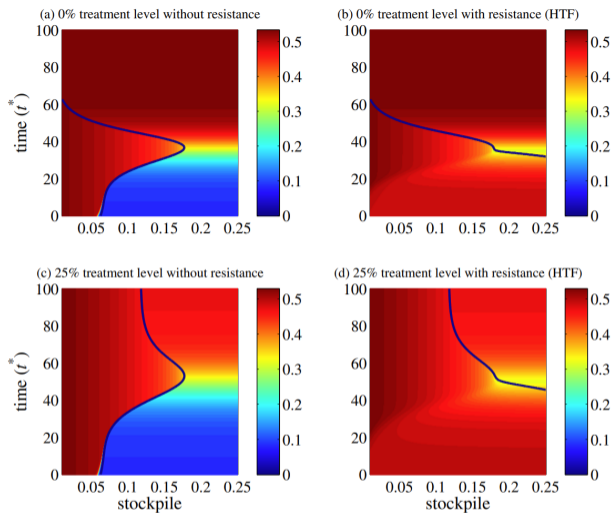

Figure 5

Final size of infections with adaptive treatment strategy. The effect of changing treatment level during the outbreak on the total number of clinical infections caused by all strains, with various sizes of stockpile and $R_0 = 2$. Simulations were seeded with an initial treatment level of: (a) 0% without resistance; (b) 0% with resistance; (c) 25% without resistance; (d) 25% with resistance, and then changed to 80% at the time displayed on the vertical axis (corresponding to the time-course of the outbreak). The color bars illustrate the ratio of the total number of clinical infection to S_0 due to all strains. Run-out occurs in the regions consisting of the origin and delimited by the solid curves.

Kermack-McKendrick-type epidemic models

The Kermack-McKendrick (KMK) model

Mathematical analysis of KMK

The final size of a KMK epidemic

Herd immunity in KMK

The SLIAR model

Computing the final size more efficiently

A variation on the SLIAR model

A model with vaccination

Antiviral resistance

A COVID-19 model



Contents lists available at [ScienceDirect](#)

Infectious Disease Modelling

journal homepage: www.keaipublishing.com/idm



A simple model for COVID-19

Julien Arino ^{a, b, c, *}, Stéphanie Portet ^a

^a Department of Mathematics & Data Science NEXUS, University of Manitoba, Canada

^b Centre for Disease Modelling, Canada

^c Canadian COVID-19 Mathematical Modelling Task Force, Canada



Extends the SLIAR model to take into account non-exponentially distributed stage durations (see course 02)

The original model (well, almost the first one)

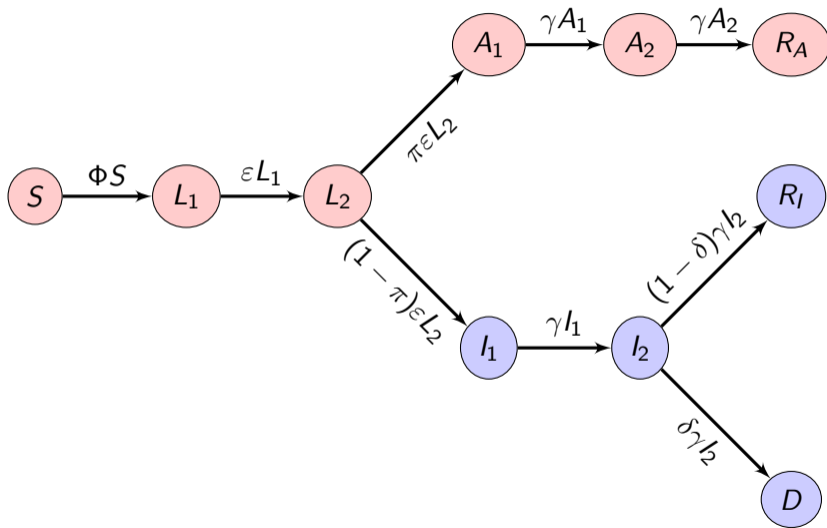

Reinterpreting terms

Here D stands for *detected*, U is *undetected*

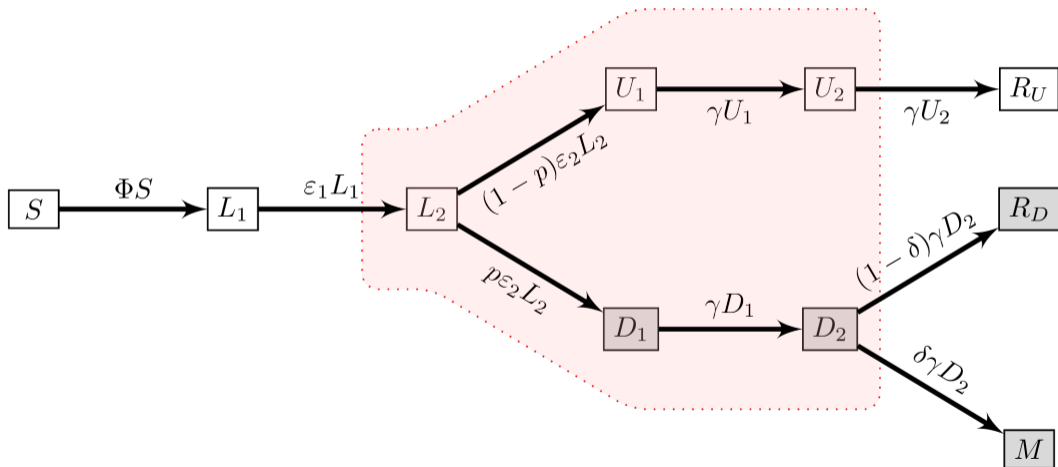

Working out when the first COVID-19 case occurred

- ▶ Details of emergence and precise timeline before amplification started unknown
- ▶ Amplification in Wuhan
 - ▶ Cluster of pneumonia cases mostly related to the Huanan Seafood Market
 - ▶ 27 December 2019: first report to local government
 - ▶ 31 December 2019: publication
 - ▶ 8 January 2020: identification of SARS-CoV-2 as causative agent
 - ▶ ~ 23 January 2020: lockdown Wuhan and Hubei province + face mask mandates
- ▶ By 2020-01-29, virus in all provinces of mainland CHN

Evidence of earlier spread

- ▶ Report to Wuhan authorities on 27 December 2019
 - ▶ First export detections in Thailand and Japan on 13 and 16 January 2020 (with actual importations on 8 and 6 January)
- ⇒ amplification must have been occurring for a while longer
- ▶ France: sample taken from 42-year-old male (last foreign travel to Algeria in August 2019) who presented to ICU on 27 December 2019
 - ▶ Retrospective studies in United Kingdom and Italy also showed undetected COVID-19 cases in pre-pandemic period

Untangling the first case issue

► Robert, Rossman & Jaric. Dating first cases of COVID-19. *PLoS Pathogens* (2021)
Find likely timing of first case of COVID-19 in China as November 17 (95% CI October 4)

► Pekar, Worobey, Moshiri, Scheffler & Wertheim. Timing the SARS-CoV-2 index case in Hubei province. *Science* (2021)
Period between mid-October and mid-November 2019 is plausible interval when the first case of SARS-CoV-2 emerged in Hubei province

Important when trying to understand global spread, so let me illustrate with the model I used, taking into account model evolution since

Back-calculating the start of spread (example of China)

Cumulative confirmed case counts in China as reported to WHO was $c = 547$ cases on $t_c = 2020-01-22$

Let u be a point in parameter space. Solve ODE numerically over $[0, t]$, with $S(0)$ the population of China, $L_1(0) = 1$ and other state variables 0. This gives a solution $x(t, t_0 = 0, u)$

Extracting $L_2(t, t_0 = 0, u)$ from this solution, obtain cumulative number of new detections as

$$C(t) = \int_{t_0=0}^t p_{\in 2} L_2(s, t_0, u) ds$$

Let t^* be s.t. $C(t^*) = 547$; then $t_i = 2020-01-22 - t^*$

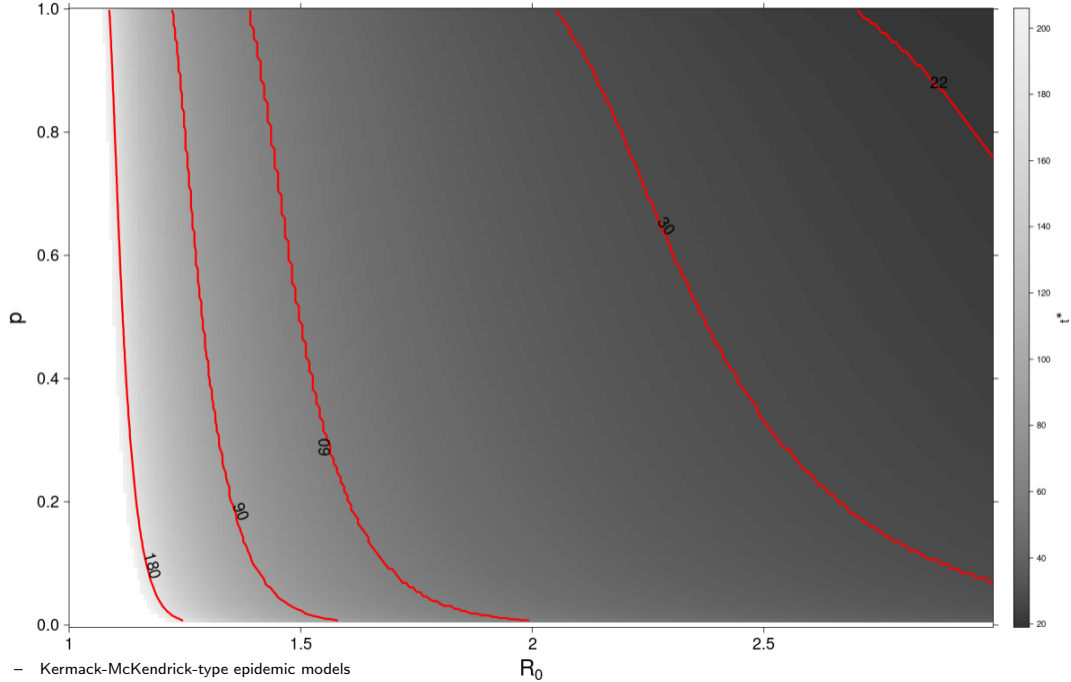



Mathematical Epidemiology

Kermack-McKendrick-type epidemic models

Endemic SIRS-type models with demography

What if there's another guest at the party?

Last remarks

Two potential variations on the Kermack-McKendrick model

- ▶ Add *vital dynamics*, i.e., consider demographic processes
- ▶ Individuals do not die from the disease; after recovering, individuals are *immune* from infection for some time
- ▶ We can of course combine both!

Potential variations

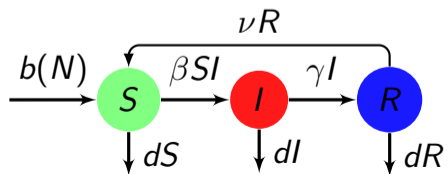
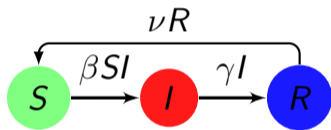
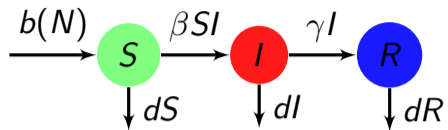

The model

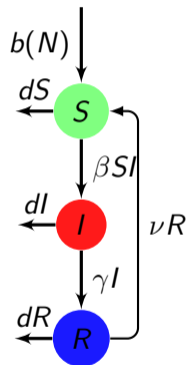

$$S' = b(N) + \nu R - dS - \beta SI \quad (26a)$$

$$I' = \beta SI - (d + \gamma)I \quad (26b)$$

$$R' = \gamma I - (d + \nu)R \quad (26c)$$

Consider the initial value problem consisting in (26) to which we adjoin initial conditions $S(0) = S_0 \geq 0$, $I(0) = I_0 \geq 0$ and $R(0) = R_0 \geq 0$

Typically, we assume $N_0 = S_0 + I_0 + R_0 > 0$ to avoid a trivial case

Birth and death are *relative*

Remark that the notions of *birth* and *death* are relative to the population under consideration

E.g., consider a model for human immunodeficiency virus (HIV) in an at-risk population of intravenous drug users. Then

- ▶ birth is the moment the at-risk behaviour starts
- ▶ death is the moment the at-risk behaviour stops, whether from “real death” or because the individual stops using drugs

Choosing a form for demography

Before we proceed with the analysis proper, we must discuss the nature of the assumptions on demography

To do this, we consider the behaviour of the total population

$$N(t) = S(t) + I(t) + R(t)$$

Behaviour of the total population

Summing the equations in (26)

$$N' = b(N) - dN \quad (27)$$

There are three common ways to define $b(N)$ in (27)

1. $b(N) = b$
2. $b(N) = bN$
3. $b(N) = bN - cN^2$

Case 3 leads to logistic dynamics of the total population and is not discussed here

Case of a birth rate constant *per capita*

If $b(N) = bN$, then birth in (27) satisfies $N'/N = b$; we say that birth is **constant per capita**

In this case, (27) takes the form

$$N' = bN - dN = (b - d)N$$

with initial condition $N(0) = N_0$

The solution to this scalar autonomous ODE is easy

$$N(t) = N_0 e^{(b-d)t}, \quad t \geq 0$$

Thus there are 3 possibilities:

- ▶ if $b > d$, $N(t) \rightarrow \infty$, the total population explodes
- ▶ if $b = d$, $N(t) \equiv N_0$, the total population remains constant
- ▶ if $b < d$, $N(t) \rightarrow 0$, the total population collapses

From now on, assume $b(N) = b$

- ▶ We want a reasonable case, we could therefore suppose that $b(N) = d$, which would lead to a constant total population

- ▶ However, this is a little reductive, so we choose instead $b(N) = b$, which, we will see, works as well even though it can initially be thought of as not being very realistic

The model (for good this time)

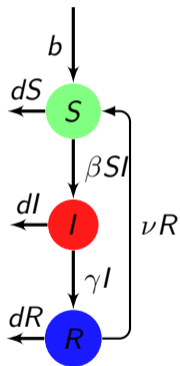

$$S' = b + \nu R - dS - \beta SI \quad (28a)$$

$$I' = \beta SI - (d + \gamma)I \quad (28b)$$

$$R' = \gamma I - (d + \nu)R \quad (28c)$$

Consider the initial value problem consisting in (28) to which we adjoin initial conditions $S(0) = S_0 \geq 0$, $I(0) = I_0 \geq 0$ and $R(0) = R_0 \geq 0$

Typically, we assume $N_0 = S_0 + I_0 + R_0 > 0$ to avoid a trivial case

Endemic SIRS-type models with demography

The SIRS model(s)

Mathematical analysis of the SIRS model

Some numerics with the SIRS model

Herd immunity in the SIRS model

SIS models

SLIRS model with constant population

Computing \mathcal{R}_0 more efficiently

A better vaccination model?

Global properties of the SLIRS model

Is the system well-posed?

For an ODE epidemiological model

- ▶ Do solutions to (28) exist and are they unique?
- ▶ Is the positive cone invariant under the flow of (28)?
- ▶ Are solutions to (28) bounded? Some models have unbounded solutions but they are rare and will need to be considered specifically

Solutions exist and are unique

- ▶ The vector field is always C^1 , implying that solutions exist and are unique

If we had instead considered an incidence of the form $f(S, I, N) = \beta SI/N$ and, say, demography with $b(N) = bN$, then some discussion might have been needed if $b < d$

Invariance of \mathbb{R}_+^3 under the flow (1)

Let us start by assuming that $I(0) = I_0 = 0$. Then (28b) remains $I' = 0$, meaning that the SR -plane (i.e., the set $\{I = 0\}$) is positively invariant under the flow of (28)

On that plane, (28) reduce to

$$S' = b + \nu R - dS \quad (29a)$$

$$R' = -(d + \nu)R \quad (29b)$$

\implies a solution with $I_0 > 0$ cannot enter the plane $\{I = 0\}$. Indeed, suppose that $I_0 > 0$ but $\exists t_\star > 0$ such that $I(t_\star) = 0$. Then at $(S(t_\star), I(t_\star) = 0, R(t_\star))$, there are two solutions to (28): the one we just generated as well as the one governed by (29)

This contradicts uniqueness of solutions to (28)

Invariance of \mathbb{R}_+^3 under the flow (2)

We saw that $I(t) > 0$ if $I(0) > 0$

Suppose now that $S = 0$. Equation (28a) is then

$$S' = b + \nu R > 0$$

So if $S(0) = S_0 > 0$, then $S(t) > 0$ for all t . If, on the other hand, $S_0 = 0$, then $S(t) > 0$ for $t > 0$ small; from what we just saw, this is then also true for all $t > 0$

We say the vector field points *inward*

$\implies S$ cannot become zero

Do the same for R

To summarise, for invariance

For simplicity, denote $\mathbb{R}^* = \mathbb{R} \setminus \{0\}$

► If $(S(0), I(0), R(0)) \in \mathbb{R}_+ \times \mathbb{R}_+^* \times \mathbb{R}_+$, then $\forall t > 0$,

$$(S(t), I(t), R(t)) \in (\mathbb{R}_+^*)^3$$

► If $(S(0), I(0), R(0)) \in \mathbb{R}_+ \times \{0\} \times \mathbb{R}_+$, then $\forall t \geq 0$,

$$(S(t), I(t), R(t)) \in \mathbb{R}_+^* \times \{0\} \times \mathbb{R}_+$$

The model is therefore satisfactory in that it does not allow solutions to become negative

Remark – Know your audience

This reasoning has its place in an MSc or PhD manuscript: you need to demonstrate that you know what to do and how to do it

In a research paper, this is not really necessary and actually often superfluous; the statement *it is easy to show that solutions exist uniquely and that the positive orthant is invariant under the flow of the system* is typically sufficient

(However, be sure to cover your bases: don't show the proof in the paper but have it in your notes.. *it is easy to show* can be a dangerous statement if it is not easy...)

The total population is asymptotically constant

Since $b(N) = b$, the total population equation (27) takes the form

$$N' = b - dN$$

This equation has a unique equilibrium $N^* = b/d$ and it is very easy to check that this equilibrium is GAS: this is a scalar autonomous equation, so solutions are monotone; they increase to N^* if $N_0 < N^*$ and decrease to N^* if $N_0 > N^*$

So we can work at the limit N^* where $R = N^* - (S + I)$ and thus drop the equation for R

Boundedness

It follows from what we just saw that the positive cone \mathbb{R}_+^3 is (positively) invariant under the flow of (28)

Since $N(t) \rightarrow N^*$, we deduce that solutions of (28) are bounded

Seeking equilibria

We seek $S = S^*, I = I^*, R = R^*$ such that

$$0 = b + \nu R - dS - \beta SI \quad (30a)$$

$$0 = \beta SI - (d + \gamma)I \quad (30b)$$

$$0 = \gamma I - (d + \nu)R \quad (30c)$$

From (30b), either $I^* = 0$ or $\beta S - (d + \gamma) = 0$, i.e., $S^* = (d + \gamma)/\beta$

When $I^* = 0$, substituting $I^* = 0$ into (30c) implies that $R^* = 0$ and, in turn, substituting $I^* = R^* = 0$ into (30a) gives $S^* = b/d$. This gives the disease-free equilibrium (DFE)

$$\mathbf{E}_0 := (S^*, I^*, R^*) = \left(\frac{b}{d}, 0, 0 \right) \quad (31)$$

We return to $S^* = (d + \gamma)/\beta$ in a while

Classic method for computing \mathcal{R}_0

\mathcal{R}_0 is the surface in parameter space where the DFE loses its LAS

To find \mathcal{R}_0 , we therefore study the LAS of the DFE

In an arbitrary (S, I, R) , the Jacobian matrix of (28) takes the form

$$J_{(S,I,R)} = \begin{pmatrix} -d - \beta I & -\beta S & \nu \\ \beta I & \beta S - (d + \gamma) & 0 \\ 0 & \gamma & -(d + \nu) \end{pmatrix} \quad (32)$$

The LAS of the DFE depends on the sign of the real parts of the eigenvalues of (32) at that equilibrium point, so we evaluate

$$J_{E_0} = \begin{pmatrix} -d & -\beta S^* & \nu \\ 0 & \beta S^* - (d + \gamma) & 0 \\ 0 & \gamma & -(d + \nu) \end{pmatrix} \quad (33)$$

Block upper triangular matrix \implies eigenvalues are $-d < 0$, $-(d + \nu) < 0$ and $\beta S^* - (d + \gamma)$

\implies LAS of the DFE determined by sign of $\beta S^* - (d + \gamma)$

Sign of $\beta S^* - (d + \gamma)$

Recall that at the DFE (31), $S^* = b/d$, so

$$\text{sign}(\beta S^* - (d + \gamma)) = \text{sign}\left(\beta \frac{b}{d} - (d + \gamma)\right)$$

So the DFE is LAS if

$$\beta \frac{b}{d} < d + \gamma \iff \frac{\beta}{d + \gamma} \frac{b}{d} < 1$$

Denote

$$\mathcal{R}_0 = \frac{\beta}{d + \gamma} \frac{b}{d} \tag{34}$$

(We sometimes emphasise that $b/d = N^*$, the total population, and thus write $\mathcal{R}_0 = \beta N^*/(d + \gamma)$)

Seeking equilibria (2)

Now consider the second EP where $S^* = (d + \gamma)/\beta = N^*/\mathcal{R}_0$

Write (30c) as $R^* = \gamma I^*/(d + \nu)$

Since $S^* + I^* + R^* = N^*$, this means that

$$N^* - S^* - I^* = \gamma I^*/(d + \nu)$$

so substituting $S^* = N^*/\mathcal{R}_0$,

$$\left(1 + \frac{\gamma}{d + \nu}\right) I^* = \left(1 - \frac{1}{\mathcal{R}_0}\right) N^*$$

So finally

$$I^* = \left(1 - \frac{1}{\mathcal{R}_0}\right) \frac{d + \nu}{d + \nu + \gamma} N^*$$

The EEP

The **endemic equilibrium** (EEP) of (28) is

$$\mathbf{E}_* := (S^*, I^*, R^*) = \left(\frac{1}{\mathcal{R}_0} N^*, \left(1 - \frac{1}{\mathcal{R}_0}\right) \frac{d + \nu}{d + \nu + \gamma} N^*, N^* - (S^* + I^*) \right) \quad (35)$$

Remark that \mathbf{E}_* is **not biologically relevant** when $\mathcal{R}_0 \leq 1$

Theorem 8

Let the basic reproduction number be

$$\mathcal{R}_0 = \frac{\beta}{d + \gamma} N^* \quad (34)$$

and consider the EP of (28): the DFE

$$\mathbf{E}_0 = \left(\frac{b}{d}, 0, 0 \right) \quad (31)$$

and the EEP

$$\mathbf{E}_* = \left(\frac{1}{\mathcal{R}_0} N^*, \left(1 - \frac{1}{\mathcal{R}_0} \right) \frac{d + \nu}{d + \nu + \gamma} N^*, N^* - (S^* + I^*) \right) \quad (35)$$

- ▶ If $\mathcal{R}_0 < 1$, then \mathbf{E}_0 is LAS and \mathbf{E}_* is not biologically relevant
- ▶ If $\mathcal{R}_0 > 1$, then \mathbf{E}_0 is unstable and \mathbf{E}_* is biologically relevant

As you can probably guess, if $\mathcal{R}_0 > 1$, then \mathbf{E}_* is not only biologically relevant but actually also LAS

Recall the Jacobian

$$\begin{aligned} J_{(S,I,R)} &= \begin{pmatrix} -d - \beta I & -\beta S & \nu \\ \beta I & \beta S - (d + \gamma) & 0 \\ 0 & \gamma & -(d + \nu) \end{pmatrix} \\ &= \begin{pmatrix} -\beta I & -\beta S & \nu \\ \beta I & \beta S - \gamma & 0 \\ 0 & \gamma & -\nu \end{pmatrix} - d\mathbb{I} \end{aligned} \quad (32)$$

From this, we get that $-d$ is an eigenvalue of J

- ▶ there is a theorem that tells us that if $\lambda \in \sigma(M)$, then $\lambda + k \in \sigma(M + k\mathbb{I})$ ($\sigma(M)$ is the spectrum of M , the set of eigenvalues of M)
- ▶ the first matrix on the second line has all column sums zero so has a zero eigenvalue

We could continue and after some blood, sweat and tears, get that J_{E_*} has its eigenvalues with negative real parts when E_* is biologically relevant, i.e., when $\mathcal{R}_0 > 1$

With even more blood, sweat and tears, we can actually show that the result is *global*

We express that on the next slide

Theorem 9

Let the basic reproduction number be defined by (34) and consider the DFE (31) and the EEP (35)

- ▶ If $\mathcal{R}_0 < 1$, then \mathbf{E}_0 is globally asymptotically stable (GAS) and \mathbf{E}_* is not biologically relevant
- ▶ If $\mathcal{R}_0 > 1$, then \mathbf{E}_0 is unstable and \mathbf{E}_* is GAS

In other words

- ▶ when $\mathcal{R}_0 < 1$, then all solutions go to the DFE, the disease goes **extinct**
- ▶ when $\mathcal{R}_0 > 1$, then all solutions go to the EEP, the disease becomes **endemic**

Endemic SIRS-type models with demography

The SIRS model(s)

Mathematical analysis of the SIRS model

Some numerics with the SIRS model

Herd immunity in the SIRS model

SIS models

SLIRS model with constant population

Computing \mathcal{R}_0 more efficiently

A better vaccination model?

Global properties of the SLIRS model

```

library(deSolve)
rhs_SIRS <- function(t, x, p) {
  with(as.list(c(x, p)), {
    dS = b + nu * R - d * S - beta * S * I
    dI = beta * S * I - (d + gamma) * I
    dR = gamma * I - (d + nu) * R
    return(list(c(dS, dI, dR)))
  })
}
# Initial conditions
NO = 1000
IO = 1
RO = 0
IC = c(S = NO-(IO+RO), I = IO, R = RO)
# "Known" parameters
d = 1/(80*365.25)
b = NO * d

```

```

gamma = 1/14
nu = 1/365.25
# Set beta s.t. R_0 = 1.5
R_0 = 1.5
beta = R_0 * (d + gamma) / (N0-I0-R0)
params = list(b = b, d = d, gamma = gamma, beta = beta, nu = nu)
times = seq(0, 500, 1)
# Call the numerical integrator
sol_SIRS <- ode(y = IC, times = times, func = rhs_SIRS,
               parms = params, method = "ode45")
# Plot the result
plot(sol_SIRS[, "time"], sol_SIRS[, "I"],
     type = "l", lwd = 2,
     xlab = "Time (days)", ylab = "Prevalence")

```

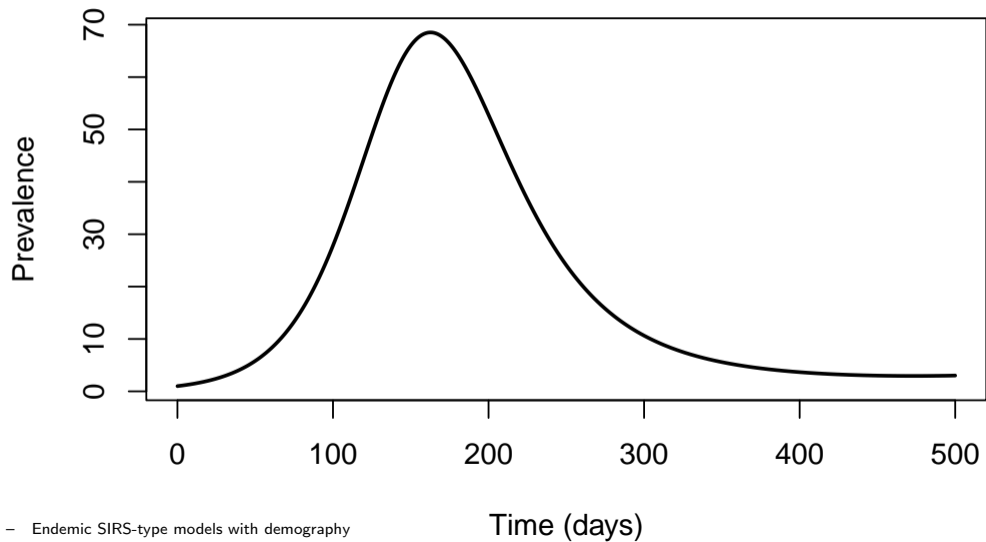

I just did ...

What I advise not to do: illustrate a mathematical result without adding anything to the result itself

Let us make things a bit better. See the code

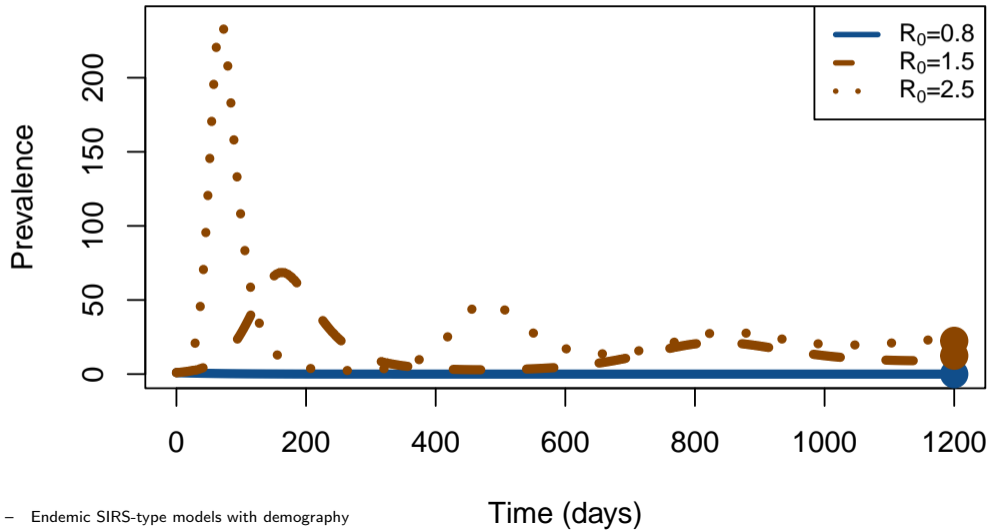

We could continue, but with a model this simple, there is little more to do: the 3 parameters of the system are combined within \mathcal{R}_0 and the latter summarises the dynamics well

We are going to show something important: the bifurcation diagram

We saw that when $\mathcal{R}_0 < 1$, $I \rightarrow 0$, whereas when $\mathcal{R}_0 > 1$, $I \rightarrow (1 - 1/\mathcal{R}_0)N$. Let us represent this (code)

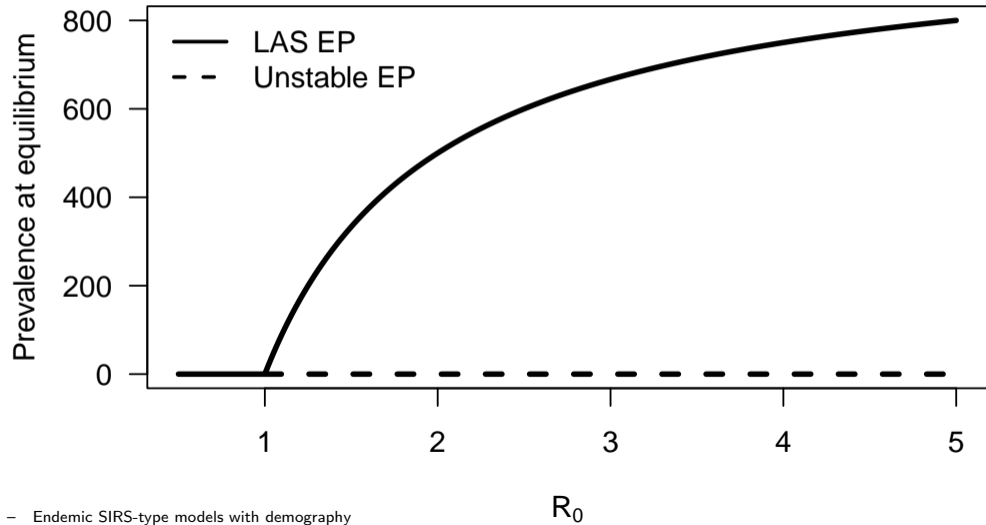

Endemic SIRS-type models with demography

The SIRS model(s)

Mathematical analysis of the SIRS model

Some numerics with the SIRS model

Herd immunity in the SIRS model

SIS models

SLIRS model with constant population

Computing \mathcal{R}_0 more efficiently

A better vaccination model?

Global properties of the SLIRS model

An SIRS model with vaccination

Take SIRS model (28) and assume the following

- ▶ Vaccination takes newborn individuals and moves them directly into the removed compartment, without them becoming infected/infectious

- ▶ A fraction p is vaccinated at birth

The model

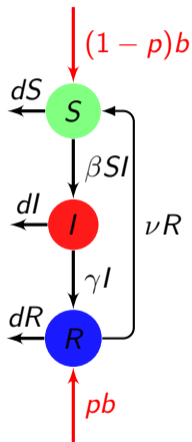

$$S' = (1-p)b + \nu R - dS - \beta SI \quad (36a)$$

$$I' = \beta SI - (d + \gamma)I \quad (36b)$$

$$R' = bp + \gamma I - (d + \nu)R \quad (36c)$$

Consider the initial value problem consisting in (36) to which we adjoin initial conditions $S(0) = S_0 \geq 0$, $I(0) = I_0 \geq 0$ and $R(0) = R_0 \geq 0$

Typically, we assume $N_0 = S_0 + I_0 + R_0 > 0$ to avoid a trivial case

This modification doesn't change much

Equation (27) for the total population is unchanged

The Jacobian (32) at arbitrary point is also unchanged

The DFE is affected, though; as a consequence, so is the reproduction number

The DFE for the SIRS vaccination model

Considering (36) at equilibrium and substituting $I^* = 0$ into this system gives

$$0 = (1 - p)b + \nu R^* - dS^*$$

$$0 = bp - (d + \nu)R^*$$

which we rewrite as the linear system

$$\begin{pmatrix} d & -\nu \\ 0 & d + \nu \end{pmatrix} \begin{pmatrix} S^* \\ R^* \end{pmatrix} = \begin{pmatrix} (1 - p)b \\ bp \end{pmatrix}$$

Thus

$$\begin{aligned} \begin{pmatrix} S^* \\ R^* \end{pmatrix} &= \frac{1}{d(d + \nu)} \begin{pmatrix} d + \nu & \nu \\ 0 & d \end{pmatrix} \begin{pmatrix} (1 - p)b \\ pb \end{pmatrix} \\ &= \frac{1}{d(d + \nu)} \begin{pmatrix} (d + \nu)(1 - p)b + pb\nu \\ pbd \end{pmatrix} \end{aligned}$$

As a consequence, the DFE takes the form

$$\mathbf{E}_0^v := (S^*, I^*, R^*) = \left(\left(1 - p + \frac{p\nu}{d + \nu} \right) N^*, 0, \frac{pd}{d + \nu} N^* \right) \quad (37)$$

Substituting (37) into the eigenvalue that determines stability of the DFE, $\beta S^* - (d + \gamma)$, we get

$$\begin{aligned} \beta S^* - (d + \gamma) < 0 &\iff \frac{\beta}{d + \gamma} S^* < 1 \\ &\iff \frac{\beta}{d + \gamma} \left(1 - p + \frac{p\nu}{d + \nu} \right) N^* < 1 \end{aligned}$$

So we define

$$\mathcal{R}_0^v = \frac{\beta}{d + \gamma} \left(1 - p + \frac{p\nu}{d + \nu} \right) N^* \quad (38)$$

Herd immunity

Therefore

- ▶ $\mathcal{R}_0^v < \mathcal{R}_0$ if $p > 0$
- ▶ To control the disease, \mathcal{R}_v must take a value less than 1, i.e.,

$$\mathcal{R}_v < 1 \iff p > 1 - \frac{1}{\mathcal{R}_0} \quad (39)$$

By vaccinating a fraction $p > 1 - 1/\mathcal{R}_0$ of newborns, we thus are in a situation where the disease is eventually eradicated

This is **herd immunity** (*bis repetita*)

Endemic SIRS-type models with demography

The SIRS model(s)

Mathematical analysis of the SIRS model

Some numerics with the SIRS model

Herd immunity in the SIRS model

SIS models

SLIRS model with constant population

Computing \mathcal{R}_0 more efficiently

A better vaccination model?

Global properties of the SLIRS model

Note on demography

- ▶ We have already discussed some different possible forms for demography

- ▶ In the models with demography here, unless otherwise required, we use demography such that for the total population

$$N' = b - dN$$

Simplifying the SIRS model

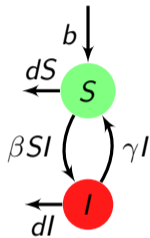

► We have already seen the epidemic KMK SIR model and the endemic SIRS model

► By making some simplifications of the endemic SIRS model, we obtain the SIS model: assume the time spent in the R compartment goes to zero, i.e., $\nu \rightarrow \infty$

The main characteristics of the model are the same as the SIRS

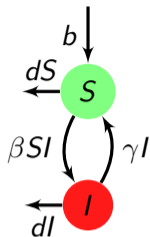

$$S' = b + \gamma I - dS - \beta SI \quad (40a)$$

$$I' = \beta SI - (d + \gamma)I \quad (40b)$$

with initial conditions $S(0) = S_0 \geq 0$ and $I(0) = I_0 \geq 0$

Clearly, the DFE is similar as for the SIRS

$$\mathbf{E}_0 := (S^*, I^*) = (N^*, 0)$$

with $N^* = b/d$. Also easy to check (exercise!) that

$$\mathcal{R}_0 = \frac{\beta}{d + \gamma}$$

Endemic SIRS-type models with demography

The SIRS model(s)

Mathematical analysis of the SIRS model

Some numerics with the SIRS model

Herd immunity in the SIRS model

SIS models

SLIRS model with constant population

Computing \mathcal{R}_0 more efficiently

A better vaccination model?

Global properties of the SLIRS model

Incubation periods

- ▶ SIS and SIR: progression from S to I is instantaneous
- ▶ Several incubation periods:

Disease	Incubation period
Yersinia Pestis	2-6 days
Ebola haemorrhagic fever (HF)	2-21 days
Marburg HF	5-10 days
Lassa fever	1-3 weeks
Tse-tse	weeks–months
HIV/AIDS	months–years

Hypotheses

- ▶ There is demography
- ▶ New individuals are born at a constant rate b
- ▶ There is no vertical transmission: all “newborns” are susceptible
- ▶ The disease is non lethal, it causes no additional mortality
- ▶ New infections occur at the rate $f(S, I, N)$
- ▶ There is a period of incubation for the disease
- ▶ There is a period of time after recovery during which the disease confers immunity to reinfection (immune period)

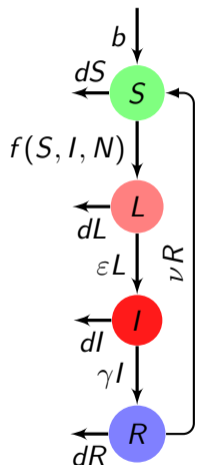

The model is as follows:

$$S' = b + \nu R - dS - f(S, I, N) \quad (41a)$$

$$L' = f(S, I, N) - (d + \varepsilon)L \quad (41b)$$

$$I' = \varepsilon L - (d + \gamma)I \quad (41c)$$

$$R' = \gamma I - (d + \nu)R \quad (41d)$$

Meaning of the parameters:

- ▶ $1/\varepsilon$ average duration of the incubation period
- ▶ $1/\gamma$ average duration of infectious period
- ▶ $1/\nu$ average duration of immune period

Endemic SIRS-type models with demography

The SIRS model(s)

Mathematical analysis of the SIRS model

Some numerics with the SIRS model

Herd immunity in the SIRS model

SIS models

SLIRS model with constant population

Computing \mathcal{R}_0 more efficiently

A better vaccination model?

Global properties of the SLIRS model



ELSEVIER

Mathematical Biosciences 180 (2002) 29–48

**Mathematical
Biosciences**

www.elsevier.com/locate/mbs

Reproduction numbers and sub-threshold endemic equilibria for compartmental models of disease transmission

P. van den Driessche ^{a,1}, James Watmough ^{b,*,2}

^a *Department of Mathematics and Statistics, University of Victoria, Victoria, BC, Canada V8W 3P4*

^b *Department of Mathematics and Statistics, University of New Brunswick, Fredericton, NB, Canada E3B 5A3*

Received 26 April 2001; received in revised form 27 June 2001; accepted 27 June 2001

Dedicated to the memory of John Jacquez

The basic reproduction number \mathcal{R}_0

Used frequently in epidemiology (not only math epi)

Definition 10 (R_0)

The basic reproduction number \mathcal{R}_0 is the average number of secondary cases generated by the introduction of an infectious individual in a wholly susceptible population

- ▶ If $\mathcal{R}_0 < 1$, then on average, each infectious individual infects less than one other person, so the epidemic has chances of dying out
- ▶ If $\mathcal{R}_0 > 1$, then on average, each infectious individual infects more than one other person and the disease can become established in the population (or there will be a major epidemic)

Computation of \mathcal{R}_0

Mathematically, \mathcal{R}_0 is a bifurcation parameter aggregating some of the model parameters and such that the disease free equilibrium (DFE) loses its local asymptotic stability when $\mathcal{R}_0 = 1$ is crossed from left to right

- ▶ As a consequence, \mathcal{R}_0 is found by considering the spectrum of the Jacobian matrix of the system evaluated at the DFE
- ▶ The matrix quickly becomes hard to deal with (size and absence of “pattern”) and the form obtained is not unique, which is annoying when trying to interpret \mathcal{R}_0

Preliminary setup of PvdD & Watmough 2002

$x = (x_1, \dots, x_n)^T$, $x_i \geq 0$, with the first $m < n$ compartments the infected ones
 X_s the set of all disease free states:

$$X_s = \{x \geq 0 \mid x_i = 0, i = 1, \dots, m\}$$

Distinguish new infections from all other changes in population

- ▶ $F_i(x)$ rate of appearance of new infections in compartment i
- ▶ $V_i^+(x)$ rate of transfer of individuals into compartment i by all other means
- ▶ $V_i^-(x)$ rate of transfer of individuals out of compartment i

Assume each function continuously differentiable at least twice in each variable

$$x'_i = f_i(x) = F_i(x) - V_i(x), \quad i = 1, \dots, n$$

where $V_i = V_i^- - V_i^+$

Some assumptions

- ▶ **(A1)** If $x \geq 0$, then $F_i, V_i^+, V_i^- \geq 0$ for $i = 1, \dots, n$

Since each function represents a directed transfer of individuals, all are non-negative

- ▶ **(A2)** If $x_i = 0$ then $V_i^- = 0$. In particular, if $x \in X_s$, then $V_i^- = 0$ for $i = 1, \dots, m$

If a compartment is empty, there can be no transfer of individuals out of the compartment by death, infection, nor any other means

► **(A3)** $F_i = 0$ if $i > m$

The incidence of infection for uninfected compartments is zero

► **A4** If $x \in X_s$ then $F_i(x) = 0$ and $V_i^+(x) = 0$ for $i = 1, \dots, m$

Assume that if the population is free of disease then the population will remain free of disease; i.e., there is no (density independent) immigration of infectives

One last assumption for the road

Let x_0 be a DFE of the system, i.e., a (locally asymptotically) stable equilibrium solution of the disease free model, i.e., the system restricted to X_S . We need not assume that the model has a unique DFE

Let $Df(x_0)$ be the Jacobian matrix $[\partial f_i / \partial x_j]$. Some derivatives are one sided, since x_0 is on the domain boundary

(A5) If $F(x)$ is set to zero, then all eigenvalues of $Df(x_0)$ have negative real parts

Note: if the method ever fails to work, it is usually with (A5) that lies the problem

Stability of the DFE as function of \mathcal{R}_0

Theorem 11

Suppose the DFE exists. Let then

$$\mathcal{R}_0 = \rho(FV^{-1})$$

with matrices F and V obtained as indicated. Assume conditions (A1) through (A5) hold. Then

- ▶ *if $\mathcal{R}_0 < 1$, then the DFE is LAS*
- ▶ *if $\mathcal{R}_0 > 1$, the DFE is unstable*

Important to stress *local* nature of stability that is deduced from this result. We will see later that even when $\mathcal{R}_0 < 1$, there can be several positive equilibria

Direction of the bifurcation at $\mathcal{R}_0 = 1$

μ bifurcation parameter s.t. $\mathcal{R}_0 < 1$ for $\mu < 0$ and $\mathcal{R}_0 > 1$ for $\mu > 0$ and x_0 DFE for all values of μ and consider the system

$$x' = f(x, \mu) \quad (42)$$

Write

$$D_x f(x_0, 0) = D(\mathcal{F}(x_0) - \mathcal{V}(x_0))|_{\mathcal{R}_0=1}$$

as block matrix

$$D\mathcal{F}(x_0) = \begin{pmatrix} F & 0 \\ 0 & 0 \end{pmatrix}, \quad D\mathcal{V}(x_0) = \begin{pmatrix} V & 0 \\ J_3 & J_4 \end{pmatrix}$$

Write $[\alpha_{\ell k}]$, $\ell = m + 1, \dots, n$, $k = 1, \dots, m$ the $(\ell - m, k)$ entry of $-J_4^{-1}J_3$ and let v and w be left and right eigenvectors of $D_x f(x_0, 0)$ s.t. $vw = 1$

Let

$$a = \sum_{i,j,k=1}^m v_i w_j w_k \left(\frac{1}{2} \frac{\partial^2 f_i}{\partial x_j \partial x_k}(x_0, 0) + \sum_{\ell=m+1}^n \alpha_{\ell k} \frac{\partial^2 f_i}{\partial x_j \partial x_\ell}(x_0, 0) \right) \quad (43)$$

$$b = v D_{x\mu} f(x_0, 0) w = \sum_{i,j=1}^n v_i w_j \frac{\partial^2 f_i}{\partial x_j \partial \mu}(x_0, 0) \quad (44)$$

Theorem 12

Consider model (42) with $f(x, \mu)$ satisfying conditions (A1)–(A5) and μ as described above

Assume that the zero eigenvalue of $D_x f(x_0, 0)$ is simple

Define a and b by (43) and (44); assume that $b \neq 0$. Then $\exists \delta > 0$ s.t.

- ▶ if $a < 0$, then there are LAS endemic equilibria near x_0 for $0 < \mu < \delta$
- ▶ if $a > 0$, then there are unstable endemic equilibria near x_0 for $-\delta < \mu < 0$

Example of the SLIRS model (41)

Variation of the infected variables in (41) are described by

$$L' = f(S, I, N) - (\varepsilon + d)L$$

$$I' = \varepsilon L - (d + \gamma)I$$

Write

$$\mathcal{I}' = \begin{pmatrix} L \\ I \end{pmatrix}' = \begin{pmatrix} f(S, I, N) \\ 0 \end{pmatrix} - \begin{pmatrix} (\varepsilon + d)L \\ (d + \gamma)I - \varepsilon L \end{pmatrix} =: \mathcal{F} - \mathcal{V} \quad (45)$$

Denote

$$f_L^* := \left. \frac{\partial}{\partial L} f \right|_{(S,I,R)=\mathbf{E}_0} \quad f_I^* := \left. \frac{\partial}{\partial I} f \right|_{(S,I,R)=\mathbf{E}_0}$$

the values of the partials of the incidence function at the DFE \mathbf{E}_0

Compute the Jacobian matrices of vectors \mathcal{F} and \mathcal{V} at the DFE \mathbf{E}_0

$$F = \begin{pmatrix} f_L^* & f_I^* \\ 0 & 0 \end{pmatrix} \quad \text{and} \quad V = \begin{pmatrix} \varepsilon + d & 0 \\ -\varepsilon & d + \gamma \end{pmatrix} \quad (46)$$

Thus

$$V^{-1} = \frac{1}{(d + \varepsilon)(d + \gamma)} \begin{pmatrix} d + \gamma & 0 \\ \varepsilon & d + \varepsilon \end{pmatrix}$$

Also, in the case N is constant, $\partial f / \partial L = 0$ and thus

$$FV^{-1} = \frac{f_I^*}{(d + \varepsilon)(d + \gamma)} \begin{pmatrix} \varepsilon & d + \varepsilon \\ 0 & 0 \end{pmatrix}$$

As a consequence,

$$\mathcal{R}_0 = \varepsilon \frac{f_I^*}{(d + \varepsilon)(d + \gamma)}$$

Theorem 13

Let

$$\mathcal{R}_0 = \frac{\varepsilon f_I^*}{(d + \varepsilon)(d + \gamma)} \quad (47)$$

Then

- ▶ if $\mathcal{R}_0 < 1$, the DFE is LAS
- ▶ if $\mathcal{R}_0 > 1$, the DFE is unstable

It is important here to stress that the result we obtain concerns the **local** asymptotic stability. We see later that even when $\mathcal{R}_0 < 1$, there can be several locally asymptotically stable equilibria

Application

The DFE is

$$(\bar{S}, \bar{L}, \bar{I}, \bar{R}) = (N, 0, 0, 0)$$

- ▶ Mass action incidence (frequency-dependent contacts):

$$f_I^* = \beta \bar{S} \Rightarrow \mathcal{R}_0 = \frac{\epsilon \beta N}{(\epsilon + d)(\gamma + d)}$$

- ▶ Standard incidence (proportion-dependent contacts):

$$f_I^* = \frac{\beta \bar{S}}{N} \Rightarrow \mathcal{R}_0 = \frac{\epsilon \beta}{(\epsilon + d)(\gamma + d)}$$

Links between SLIRS-type models

$$S' = b + \nu R - dS - f(S, I, N)$$

$$L' = f(S, I, N) - (d + \varepsilon)L$$

$$I' = \varepsilon L - (d + \gamma)I$$

$$R' = \gamma I - (d + \nu)R$$

SLIR	SLIRS where $\nu = 0$
SLIS	Limit of SLIRS when $\nu \rightarrow \infty$
SLI	SLIR where $\gamma = 0$
SIRS	Limit of SLIRS when $\varepsilon \rightarrow \infty$
SIR	SIRS where $\nu = 0$
SIS	Limit of SIRS when $\nu \rightarrow \infty$
	Limit SLIS when $\varepsilon \rightarrow \infty$
SI	SIS where $\nu = 0$

Values of \mathcal{R}_0

$(\bar{S}, \bar{I}, \bar{N})$ values of S, I and N at DFE. Denote $\bar{f}_I = \partial f / \partial I(\bar{S}, \bar{I}, \bar{N})$.

SLIRS	$\frac{\varepsilon \bar{f}_I}{(d+\varepsilon)(d+\gamma)}$
SLIR	$\frac{\varepsilon \bar{f}_I}{(d+\varepsilon)(d+\gamma)}$
SLIS	$\frac{\varepsilon \bar{f}_I}{(d+\varepsilon)(d+\gamma)}$
SLI	$\frac{\varepsilon \bar{f}_I}{(d+\varepsilon)(d+\gamma)}$
SIRS	$\frac{\varepsilon \bar{f}_I}{d+\gamma}$
SIR	$\frac{\bar{f}_I}{d+\gamma}$
SIS	$\frac{\bar{f}_I}{d+\gamma}$
SI	$\frac{\bar{f}_I}{d+\gamma}$

Endemic SIRS-type models with demography

The SIRS model(s)

Mathematical analysis of the SIRS model

Some numerics with the SIRS model

Herd immunity in the SIRS model

SIS models

SLIRS model with constant population

Computing \mathcal{R}_0 more efficiently

A better vaccination model?

Global properties of the SLIRS model

GLOBAL RESULTS FOR AN EPIDEMIC MODEL WITH VACCINATION THAT EXHIBITS BACKWARD BIFURCATION*

JULIEN ARINO[†], C. CONNELL MCCLUSKEY[†], AND P. VAN DEN DRIESSCHE[†]

Abstract. Vaccination of both newborns and susceptibles is included in a transmission model for a disease that confers immunity. The interplay of the vaccination strategy together with the vaccine efficacy and waning is studied. In particular, it is shown that a backward bifurcation leading to bistability can occur. Under mild parameter constraints, compound matrices are used to show that each orbit limits to an equilibrium. In the case of bistability, this global result requires a novel approach since there is no compact absorbing set.

Key words. epidemic model, vaccination, backward bifurcation, compound matrices, global dynamics

AMS subject classifications. 92D30, 34D23

DOI. 10.1137/S0036139902413829

SLIRS with vaccination

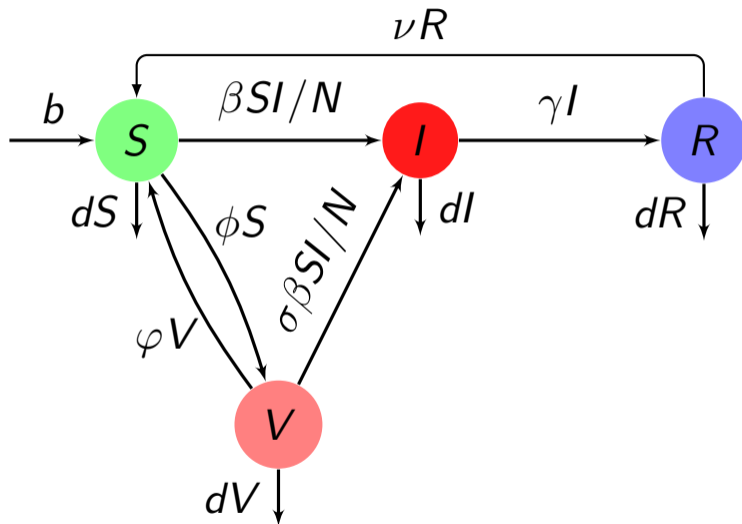

The usual situation

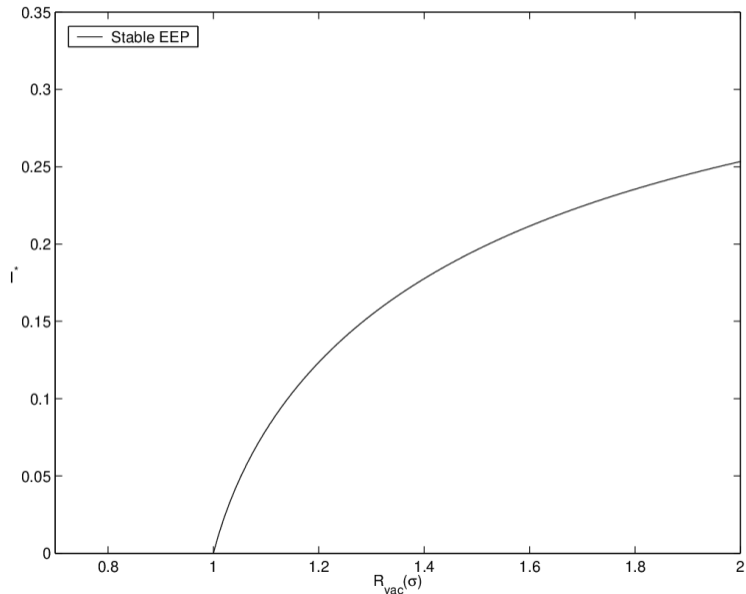

What can happen with vaccination – Backward bifurcation

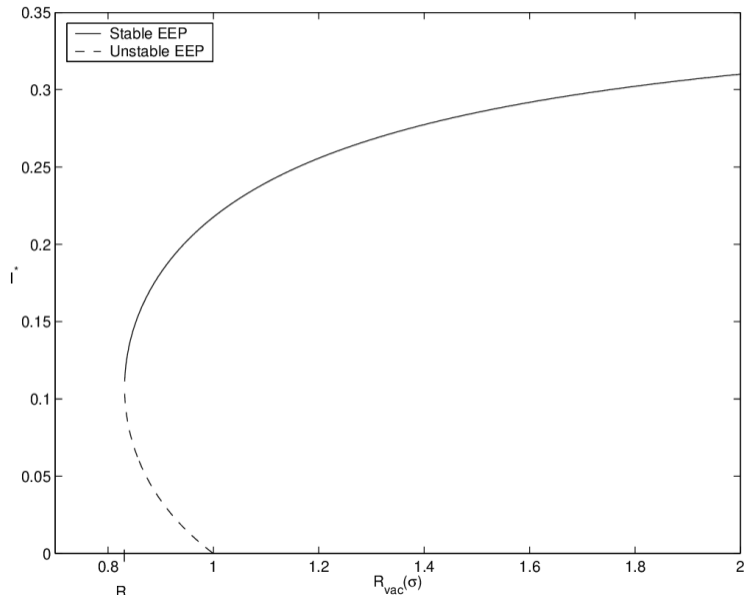

Endemic SIRS-type models with demography

The SIRS model(s)

Mathematical analysis of the SIRS model

Some numerics with the SIRS model

Herd immunity in the SIRS model

SIS models

SLIRS model with constant population

Computing \mathcal{R}_0 more efficiently

A better vaccination model?

Global properties of the SLIRS model

Mathematical Medicine and Biology (2004) **21**, 75–83

**Lyapunov functions and global properties for *SEIR* and
SEIS epidemic models**

ANDREI KOROBENIKOV†

*Centre for Mathematical Biology, Mathematical Institute, University of Oxford,
24–29 St Giles', Oxford OX1 3LB, UK*

[Received on 16 May 2003; revised on 10 December 2003]

Lyapunov function for SLIR and SLIS

Consider an SLIR in constant population (normed to 1), with vertical transmission

$$S' = d - \beta SI - pdI - qdL - dS \quad (48a)$$

$$L' = \beta SI + pdI - (\varepsilon + d - qd)L \quad (48b)$$

$$I' = \varepsilon L - (\gamma + d)I \quad (48c)$$

p proportion of progeny of I that are I at birth, q proportion of progeny of L that are L at birth

R does not play a role in the dynamics of (48), it is not shown

Equilibria

- ▶ DFE: $\mathbf{E}_0 = (1, 0, 0)$.
- ▶ EEP: $\mathbf{E}_* = (S^*, L^*, I^*)$ with

$$S^* = \frac{1}{\mathcal{R}_0^v} \quad L^* = \frac{d}{\varepsilon + d} \left(1 - \frac{1}{\mathcal{R}_0^v}\right) \quad I^* = \frac{d\varepsilon}{(\varepsilon + d)(\gamma + d)} \left(1 - \frac{1}{\mathcal{R}_0^v}\right)$$

where

$$\mathcal{R}_0^v = \frac{\beta\varepsilon}{(\gamma + d)(\varepsilon + d) - qd(\varepsilon + d) - pd\varepsilon}$$

is the basic reproduction number with vertical transmission

We have $\mathcal{R}_0 = \mathcal{R}_0^v \iff p = q = 0$ or $\mathcal{R}_0^v = \mathcal{R}_0 = 1$

\mathbf{E}_* exists (in a biologically plausible way) only when $\mathcal{R}_0^v > 1$

Consider the Goh Lyapunov function

$$V = \sum a_i(x_i - x_i^* \ln x_i)$$

Theorem 14

- ▶ *If $\mathcal{R}_0 > 1$, then (48) has the globally asymptotically stable equilibrium \mathbf{E}_**
- ▶ *If $\mathcal{R}_0 \leq 1$, then (48) has the globally asymptotically stable equilibrium \mathbf{E}_0 , \mathbf{E}_* is not biologically plausible*

CANADIAN APPLIED
MATHEMATICS QUARTERLY
Volume 7, Number 4, Winter 1999

**GLOBAL STABILITY OF
SEIRS MODELS IN EPIDEMIOLOGY**

MICHAEL Y. LI, JAMES S. MULDOWNNEY AND P. VAN DEN DRIESSCHE

Li, Muldowney and van den Driessche

Study an SLIRS model with incidence of the form

$$f(S, I, N) = \beta g(I)S \quad (49)$$

where g is such that $g(0) = 0$, $g(I) > 0$ for $I \in (0, 1]$ and $g \in C^1(0, 1]$

They normalise the total population, so that $S + L + I + R = 1$

They make the following assumption about g :

(H) $c = \lim_{I \rightarrow 0^+} \frac{g(I)}{I} \leq +\infty$; when $0 < c < +\infty$, $g(I) \leq cI$ for all sufficiently small I

We have

$$\frac{\partial \bar{f}}{\partial I} = \beta \frac{\partial \bar{g}}{\partial I}$$

$$\text{Since } \frac{\partial \bar{g}}{\partial I} = \lim_{I \rightarrow 0^+} \frac{g(I)}{I} = c,$$

$$\mathcal{R}_0 = \frac{c\beta\varepsilon}{(d + \varepsilon)(d + \gamma)}$$

The LAS results already established hold here, since (49) is a special case of the function f with which the results were obtained

The system is **uniformly persistent** if there exists $0 < \varepsilon_0 < 1$ s.t. any solution $(S(t), L(t), I(t), R(t))$ of (41) with initial condition $(S(0), L(0), I(0), R(0)) \in \overset{\circ}{\Gamma}$ satisfies

$$\begin{aligned} \liminf_{t \rightarrow \infty} S(t) &\geq \varepsilon_0, & \liminf_{t \rightarrow \infty} E(t) &\geq \varepsilon_0 \\ \liminf_{t \rightarrow \infty} I(t) &\geq \varepsilon_0, & \liminf_{t \rightarrow \infty} R(t) &\geq \varepsilon_0 \end{aligned} \quad (50)$$

Theorem 15

*If $g(I)$ satisfies hypothesis **(H)**, then (41) with incidence (49) is uniformly persistent iff $\mathcal{R}_0 > 1$*

Theorem 16

Suppose that incidence (49) satisfies **(H)** and that

$$|g'(I)|I \leq g(I) \text{ for } I \in (0, 1] \quad (51)$$

Suppose additionally that $\mathcal{R}_0 > 1$ and that one of the following conditions holds

$$\begin{aligned} \gamma\nu &< \epsilon_0(\beta\eta_0 + \gamma + d)(\beta\eta_0 + \nu + d) \\ \epsilon - \gamma - d &< \nu \end{aligned}$$

where

$$\eta_0 = \min_{I \in [\epsilon_0, 1]} g(I) > 0$$

and ϵ_0 is defined by (50)

Then there are no closed rectifiable curve that is invariant under (41). Furthermore, every semi-trajectory of (41) in Γ converges to an EP

Mathematical Epidemiology

Kermack-McKendrick-type epidemic models

Endemic SIRS-type models with demography

What if there's another guest at the party?

Last remarks

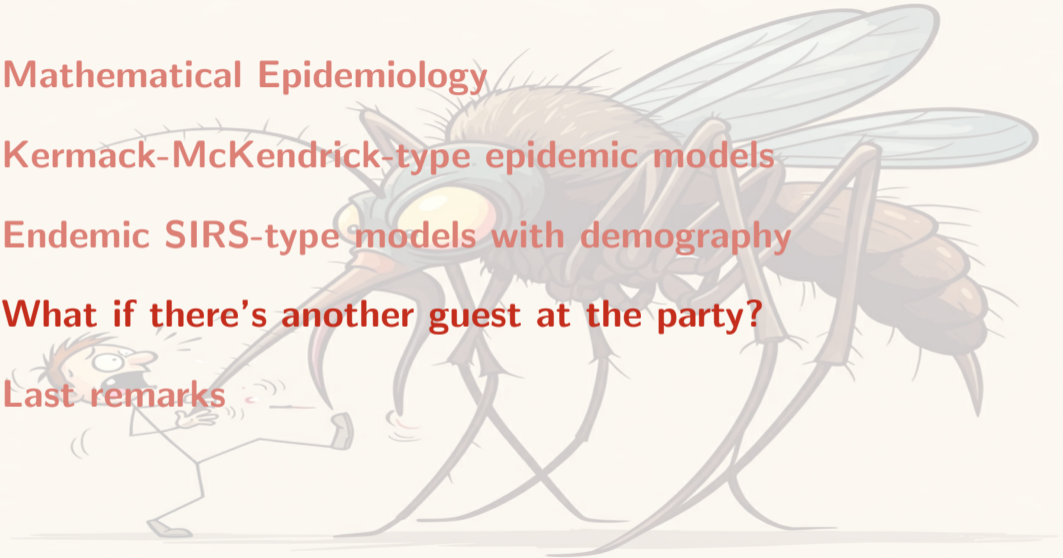

What if there's another guest at the party?

Two Ross-Macdonald-type models

A little complexification of Ross-Macdonald

A model for zoonotic transmission of waterborne disease



See, e.g., Simoy & Aparicio, Ross-Macdonald models: Which one should we use?, *Acta Tropica* (2020)

Ross introduced the model in 1911. Later “tweaked” by Macdonald to include mosquito latency period

Here, I show a version in the paper cited, with some notation changed

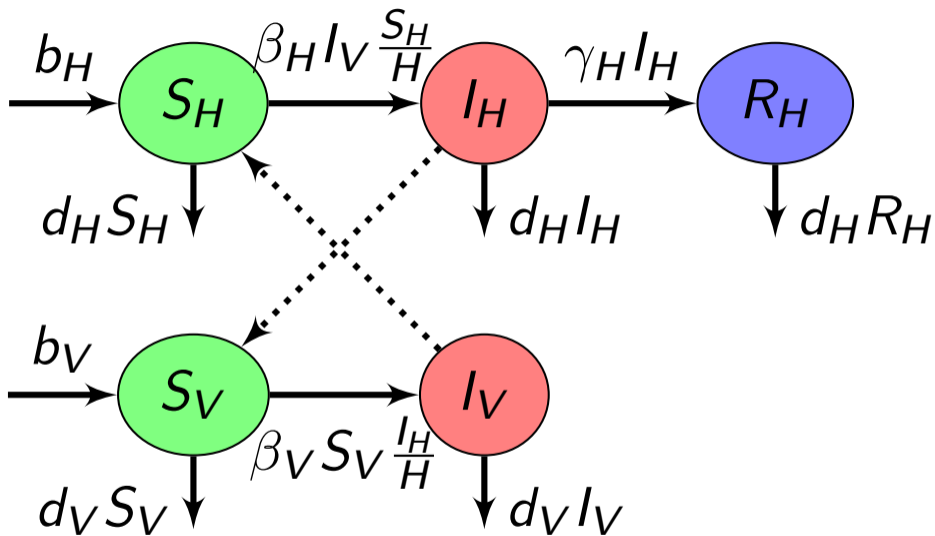

Reproduction number

$$\mathcal{R}_0 = \frac{\beta_H \beta_V}{(\gamma_H + \gamma_V) d_V} \frac{V^*}{H^*} \quad (52)$$

where H^* and V^* are the total host and vector populations, respectively

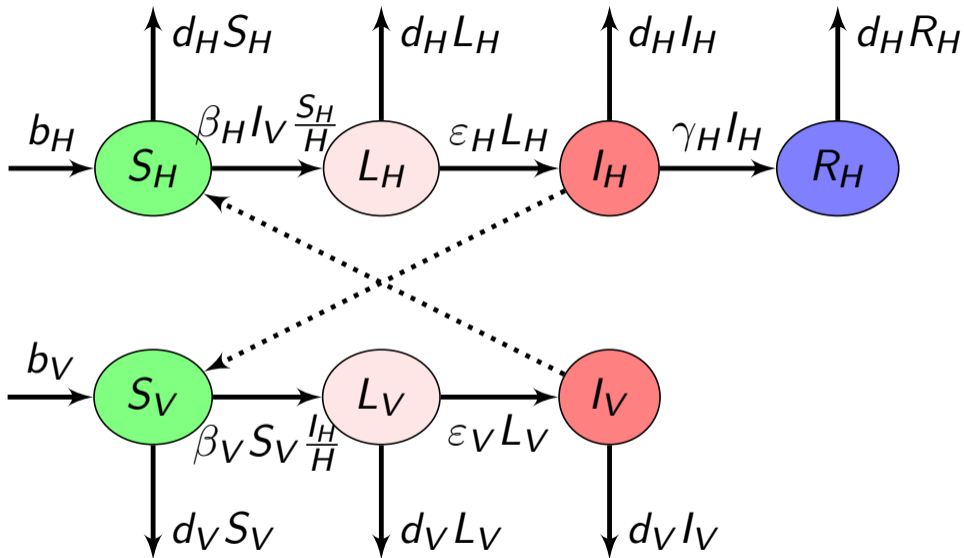

Reproduction number

$$\mathcal{R}_0 = \frac{\beta_H \beta_V}{(\gamma_H + \gamma_V) d_V} \frac{\varepsilon_V}{d_V + \varepsilon_V} \frac{\varepsilon_H}{d_H + \varepsilon_H} \frac{V^*}{H^*} \quad (53)$$

where H^* and V^* are the total host and vector populations, respectively

Here

$$f_X = \frac{\varepsilon_X}{d_X + \varepsilon_X}$$

are the fractions of latent individuals (of type $X = \{V, H\}$) who survive the latency period

What if there's another guest at the party?

Two Ross-Macdonald-type models

A little complexification of Ross-Macdonald

A model for zoonotic transmission of waterborne disease

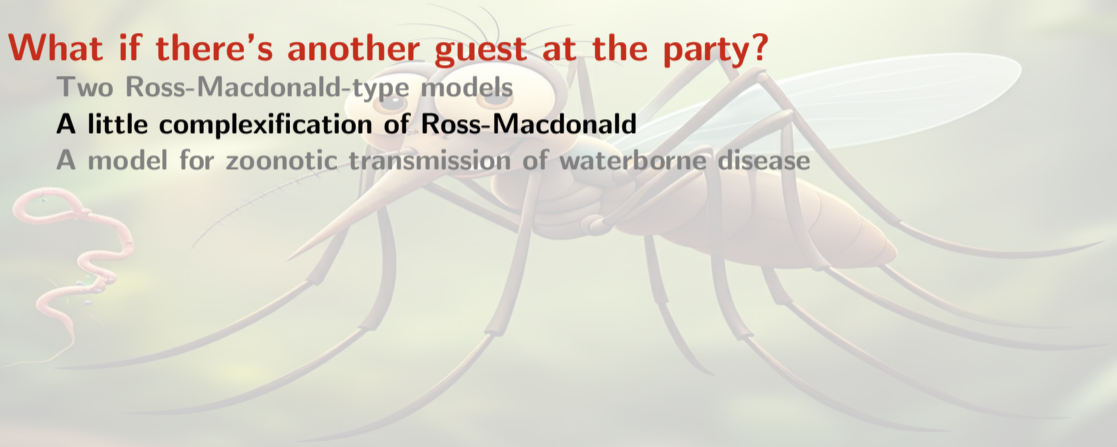

Recall this guy?

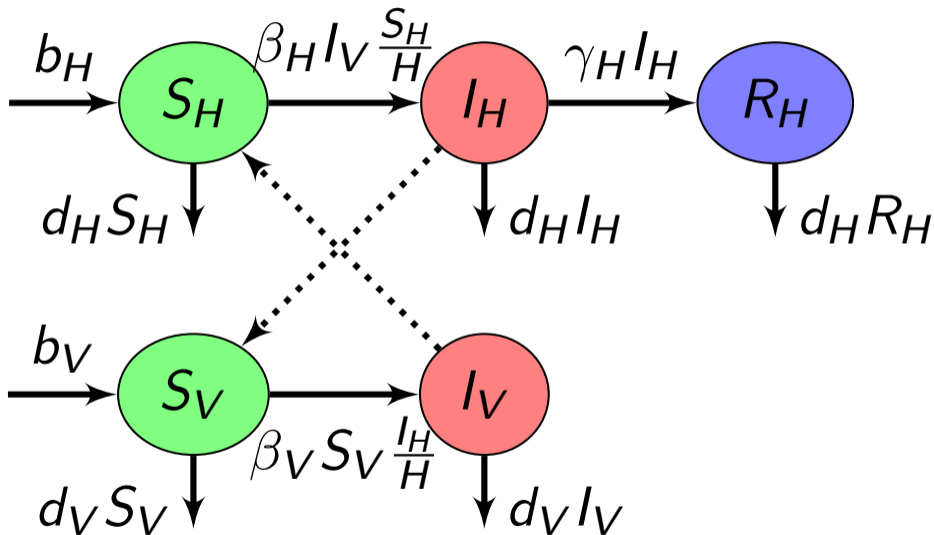

Let us add a few arrows

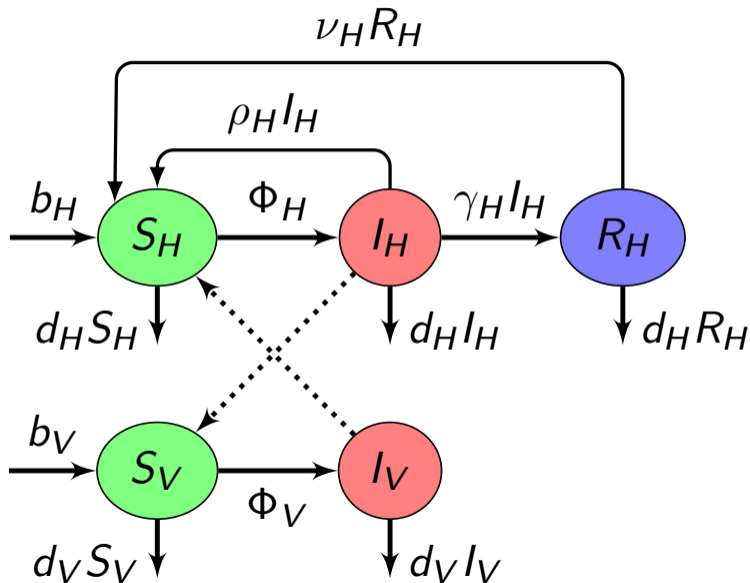

Arino, Ducrot & Zongo, A metapopulation model for malaria with transmission-blocking partial immunity in hosts, Journal of Mathematical Biology (2012)

Incidence functions take the form

$$\Phi_H = b_H(H, V)\sigma_{VH}\frac{I_V}{V}$$

and

$$\Phi_V = b_V(H, V)\left(\sigma_{HV}\frac{I_H}{H} + \hat{\sigma}_{HV}\frac{R_H}{H}\right)$$

where b_H and b_V are numbers per unit time of mosquito bites a human has and the number of humans a mosquito bites, respectively

Parameters of the incidence function

- ▶ σ_{HV} probability of transmission of the parasite (in gametocyte form) from an infectious human to a susceptible mosquito
- ▶ $\hat{\sigma}_{HV}$ probability of transmission of the parasite (in gametocyte form) from a semi-immune human to a susceptible mosquito
- ▶ σ_{VH} probability of transmission of the parasite (in sporozoite form) from an infectious mosquito to a susceptible human

Additional parameter that can be factored in (all per unit time)

- ▶ a_H maximum number of mosquito bites a human can receive
- ▶ a_V number of times one mosquito would “want to” bite humans
- ▶ a average number of bites given to humans by each mosquito

People to read for malaria models (IMOBO)

See also the work of

- ▶ Gideon Ngwa at the University of Buea
- ▶ Nakul Chitnis at the Swiss Tropical and Public Health Institute

Many others...

More complex models may be needed for malaria

Timing of processes is critical in malaria

Plasmodium life cycle in the mosquito is commensurate with mosquito lifetime

Need models that are able to account for that, because ODEs are not really good at this (see beginning of Stochastic systems lecture)

Mathematics becomes more complicated



What if there's another guest at the party?

Two Ross-Macdonald-type models

A little complexification of Ross-Macdonald

A model for zoonotic transmission of waterborne disease



Zoonotic Transmission of Waterborne Disease: A Mathematical Model

Edward K. Waters¹  · Andrew J. Hamilton² ·
Harvinder S. Sidhu³ · Leesa A. Sidhu³ ·
Michelle Dunbar⁴

Zoonotic transmission of waterborne disease

Used for instance to model Giardia transmission from possums to humans

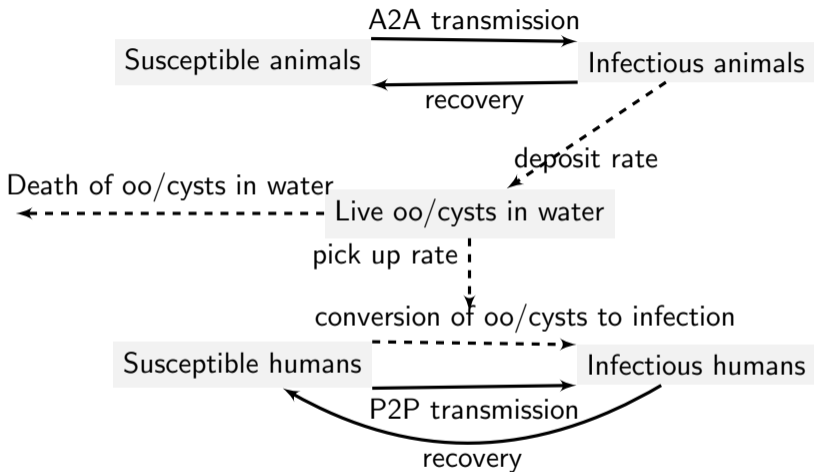

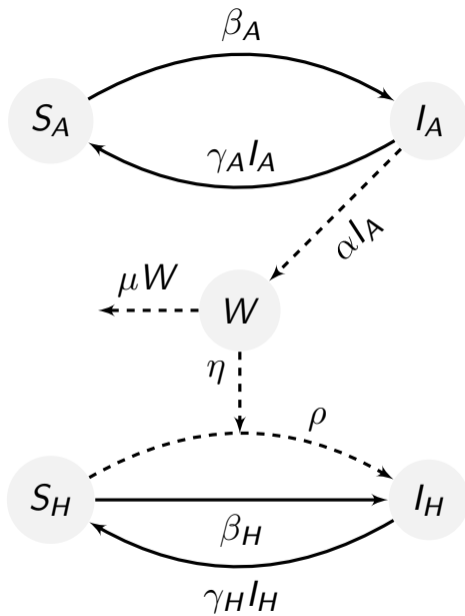

The full model

$$S_A' = -\beta_A S_A I_A + \gamma_A I_A \quad (54a)$$

$$I_A' = \beta_A S_A I_A - \gamma_A I_A \quad (54b)$$

$$W' = \alpha I_A - \eta W(S_H + I_H) - \mu W \quad (54c)$$

$$S_H' = -\rho \eta W S_H - \beta_H S_H I_H + \gamma_H I_H \quad (54d)$$

$$I_H' = \rho \eta W S_H + \beta_H S_H I_H - \gamma_H I_H \quad (54e)$$

Considered with $N_A = S_A + I_A$ and $N_H = S_H + I_H$ constant

Simplified model

Because N_A and N_H are constant, (54) can be simplified:

$$I_A' = \beta_A N_A I_A - \gamma_A I_A - \beta_A I_A^2 \quad (55a)$$

$$W' = \alpha I_A - \eta W N_H - \mu W \quad (55b)$$

$$I_H' = \rho \eta W (N_H - I_H) + \beta_H N_H I_H - \gamma_H I_H - \beta_H I_H^2 \quad (55c)$$

Three EP: DFE (0, 0, 0); endemic disease in humans because of H2H transmission;
endemic in both H and A because of W

Three EP: DFE $(0, 0, 0)$; endemic disease in humans because of H2H transmission;
endemic in both H and A because of W

Let

$$\mathcal{R}_{0A} = \frac{\beta_A}{\gamma_A} N_A \quad \text{and} \quad \mathcal{R}_{0H} = \frac{\beta_H}{\gamma_H} N_H \quad (56)$$

- ▶ DFE LAS if $\mathcal{R}_{0A} < 1$ and $\mathcal{R}_{0H} < 1$, unstable if $\mathcal{R}_{0A} > 1$ or $\mathcal{R}_{0H} > 1$
- ▶ If $\mathcal{R}_{0H} > 1$ and $\mathcal{R}_{0A} < 1$, (55) goes to EP with endemicity only in humans
- ▶ Endemic EP with both A and H requires $\mathcal{R}_{0A} > 1$ and $\mathcal{R}_{0H} < 1$

Note that proof is **not** global

Mathematical Epidemiology

Kermack-McKendrick-type epidemic models

Endemic SIRS-type models with demography

What if there's another guest at the party?

Last remarks

CONCLUSIONS



To simplify or not to simplify?

- ▶ In the KMK epidemic model (1) and the SIRS endemic model (28), since the total population is constant or asymptotically constant, it is possible to omit one of the state variables since $N^* = S + I + R$
- ▶ We often use $R = N^* - S - I$
- ▶ This can greatly simplify some computations
- ▶ Whether to do it or not is a matter of preference

To normalise or not to normalise?

- ▶ In the KMK epidemic model (1) and the SIRS endemic model (28), since the total population is constant or asymptotically constant, it is possible to normalise to $N = 1$
- ▶ This can greatly simplify some computations
- ▶ However, I am not a big fan: it is important to always have the “sizes” of objects in mind
- ▶ If you do normalise, at least for a paper destined to mathematical biology, always do a “return to biology”, i.e., interpret your results in a biological light, which often implies to return to original values

Where we are

- ▶ An *epidemic* SIR model (the KMK SIR) in which the presence or absence of an epidemic wave is characterised by the value of \mathcal{R}_0
- ▶ The KMK SIR has explicit solutions (in some sense). **This is an exception!**
- ▶ An *endemic* SIRS model in which the threshold $\mathcal{R}_0 = 1$ is such that, when $\mathcal{R}_0 < 1$, the disease goes extinct, whereas when $\mathcal{R}_0 > 1$, the disease becomes established in the population
- ▶ Some simple variations on these models
- ▶ A few models for vector-borne or water-borne diseases

CAN I HAVE THIS WRAPPED UP TO GO?

To finish, we use the command `purl` to generate an R file (`course-01-introduction-math-epi.R`) in the `CODE` directory with all the code chunks in this `Rnw` file

```
# From https://stackoverflow.com/questions/36868287/purl-within-knit-dupli
rmd_chunks_to_r_temp <- function(file){
  callr::r(function(file, temp){
    out_file = sprintf("../CODE/%s", gsub(".Rnw", ".R", file))
    knitr::purl(file, output = out_file, documentation = 1)
  }, args = list(file))
}
rmd_chunks_to_r_temp("course-01-introduction-math-epi.Rnw")

## [1] "../CODE/course-01-introduction-math-epi.R"
```



About that R file

Source the file `course-01-introduction-math-epi.R` (in the `CODE` directory) in R to reproduce all the results in these slides

Some small changes are required; for instance, when sourcing (instead of knitting or interactively), some figures are created but not printed, so in the R file, you need to print them “manually” (set the output to some variable and print them)

```
pp = ggplot(...)  
print(pp)
```

Bibliography

-  Hirsch, M. and Smale, S. (1974).
Differential Equations, Dynamical Systems, and Linear Algebra.
Academic Press.
-  van den Driessche, P. and Watmough, J. (2002).
Reproduction numbers and sub-threshold endemic equilibria for compartmental models of disease transmission.
Mathematical Biosciences, 180:29–48.